

# TAFÉE

## OPERATING MANUAL

### CONTENTS

<b>01. Bowle</b>	<b>01</b>
A. Intended Use	
B. Components and Functional Parts	
C. Technical Specifications	
D. Applied Parts	
E. Safety Directives and Standards	
<b>02. Operating Conditions and Disposal</b>	<b>02</b>
A. Operating, Storage & Transport	
B. Disposal	
<b>03. Safety Recommendations</b>	<b>03</b>
A. User Precautions	
B. Safety Recommendations	
<b>04. Indications and Unwanted Effects</b>	<b>03</b>
A. Device Indications	
B. Potential Unwanted Effects of Aromatherapy	
C. Contraindications	
<b>05. Operation of the Bowle</b>	<b>04</b>
A. Recommendations	
B. Power & Charging	
C. Lights, Buttons, and Port	
D. Selecting the Power Level	
E. Using Bowle with Drinkware (Optional)	
F. Unlocking & Power on the Puck	
G. Checking the Battery Level	
H. Stem: Assembly and Loading	
I. Inhalation Technique	
J. Locking & Power Off the Puck	
<b>06. Operation of the Herb Shredder</b>	<b>12</b>
A. Recommendations	
B. Assembling	
C. Loading Herb or Flower for Shredding	
D. Dispensing	
<b>07. Care and Maintenance</b>	<b>14</b>
A. Cleaning the Puck Base Unit	
B. Cleaning Stem, Mouthpieces, Ceramic Oven Pots, Drinkware and Herb Shredder	
<b>08. Spare Parts and Accessories</b>	<b>15</b>
<b>09. Troubleshooting</b>	<b>16</b>
<b>10. List of Symbols</b>	<b>18</b>
<b>11. Warranty Claims and Customer Service</b>	<b>18</b>

**Note:**

Images within this manual are for general illustrative guide and descriptive purposes and may not be exactly up to scale.

**Disclaimer**

This manual and the information contained therein is intended for information purposes only. It describes the safe and effective use of the Bowle, Flaske and Potter Herb Shredder for the administration of granulated natural organic herbs. The manufacturer cannot be held liable for any damage or personal injury caused by improper, irresponsible, or dangerous use of this equipment.

**Note:**

**No modification of this equipment is allowed.**

The equipment and the administration of natural organic herbs may only be used in accordance with the prescription of a healthcare professional.

Please visit our website, [tafee.com/manuals](https://tafee.com/manuals), for the most up-to-date and complete directions and guidelines.

Copyright © 2026 by Tafée™ Technologies Corporation

All rights reserved.

No part of this document may be reproduced, distributed or transmitted in any form or by any means, including photocopying, without the prior written consent of Tafée™ Technologies Corporation

# 01: BOWLE®

## A. Intended Use

Bowle® is designed specifically for utility as drinkware and the administration of natural organic herbs intended for aromatherapy by vaporization. The vaporization of natural organic compounds found in natural organic herbs and flowers allows the administration of the active ingredients through inhalation.

Flaske™ is an aromatherapy device designed with the similar architecture of Bowle. Specifically to use on the go with its compact assembly containing convenient Dose management within its embodiment.

Additionally, the herb shredder, Potter is intended to granulate the herbs and flowers improving the extraction of the ingredients and to directly fill the Ceramic Oven Pots providing an easy way to load Bowle® for operation.

The device is not to be used, if the user has respiratory tract or lung conditions. Depending on the density, the vapor could irritate respiratory tracts or lungs, which can lead to coughing. Use should be initiated and supervised by a healthcare professional.

**Note:**  
Please consult your doctor or pharmacist if you have any medical concerns. It is possible that some herbs or flowers may cause allergic reactions for the user. If this occurs, it is urgently recommended to refrain from further use of such herbs and flowers.

This statement has not been evaluated by the FDA. Bowle is not intended to diagnose, treat, cure or prevent any disease.

Never allow the Bowle, Potter it's accessories or the power adapter to be used by children or unqualified persons.

Only use original Tafée accessories and spare parts.

## B. Components and Functional Parts



**Bowle: Puck Base Unit**  
Quantity: 1



**Bowle: Stem**  
Quantity: 1

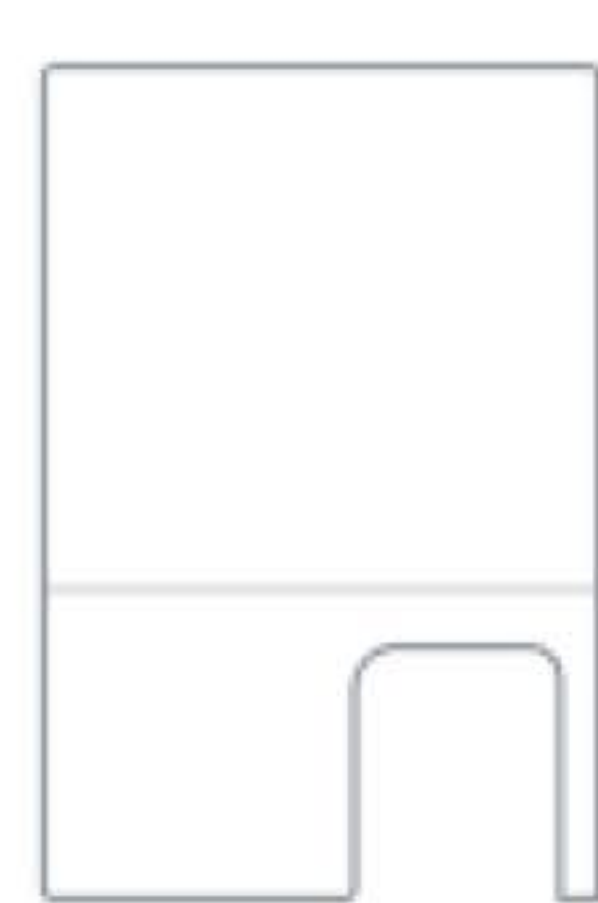

**Bowle: Drinkware**  
Quantity: 1



**Bowle: Mouthpieces**  
Quantity: 2  
Includes:  
Flat Mouthpiece  
Tall Mouthpiece



**Flaske: Stem**  
Quantity: 1

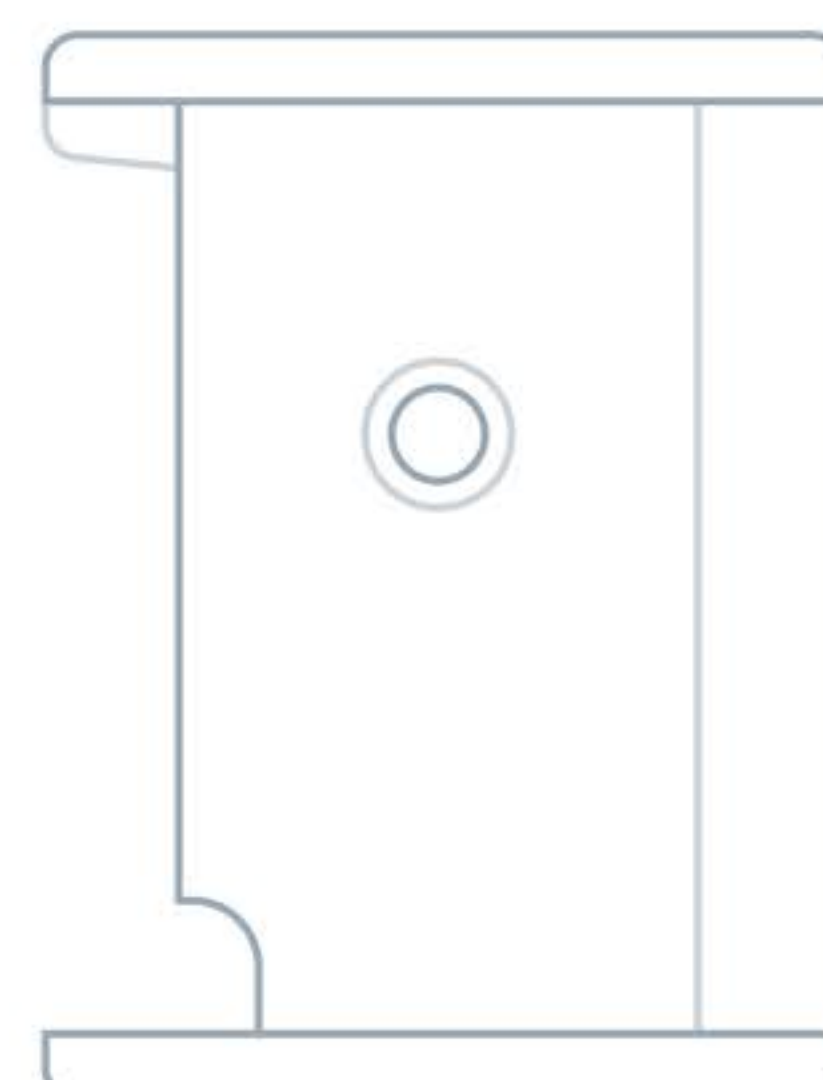

**Flaske: Power Base Unit**  
Quantity: 1



**Flaske: Mouthpieces**  
Quantity: 1  
Includes:  
Tall Mouthpiece  
Round Mouthpiece

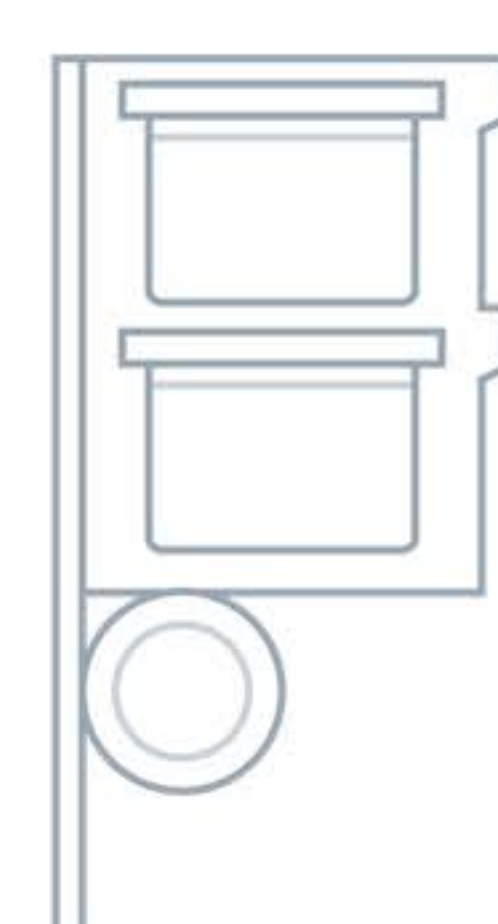

**Flaske: Session Store + Cork**  
Quantity: 1



**Ceramic Oven Pots**  
Quantity: Bowle (4) / Flaske (3)  
Includes:  
Silicone Gaskets  
Stainless Steel Screens

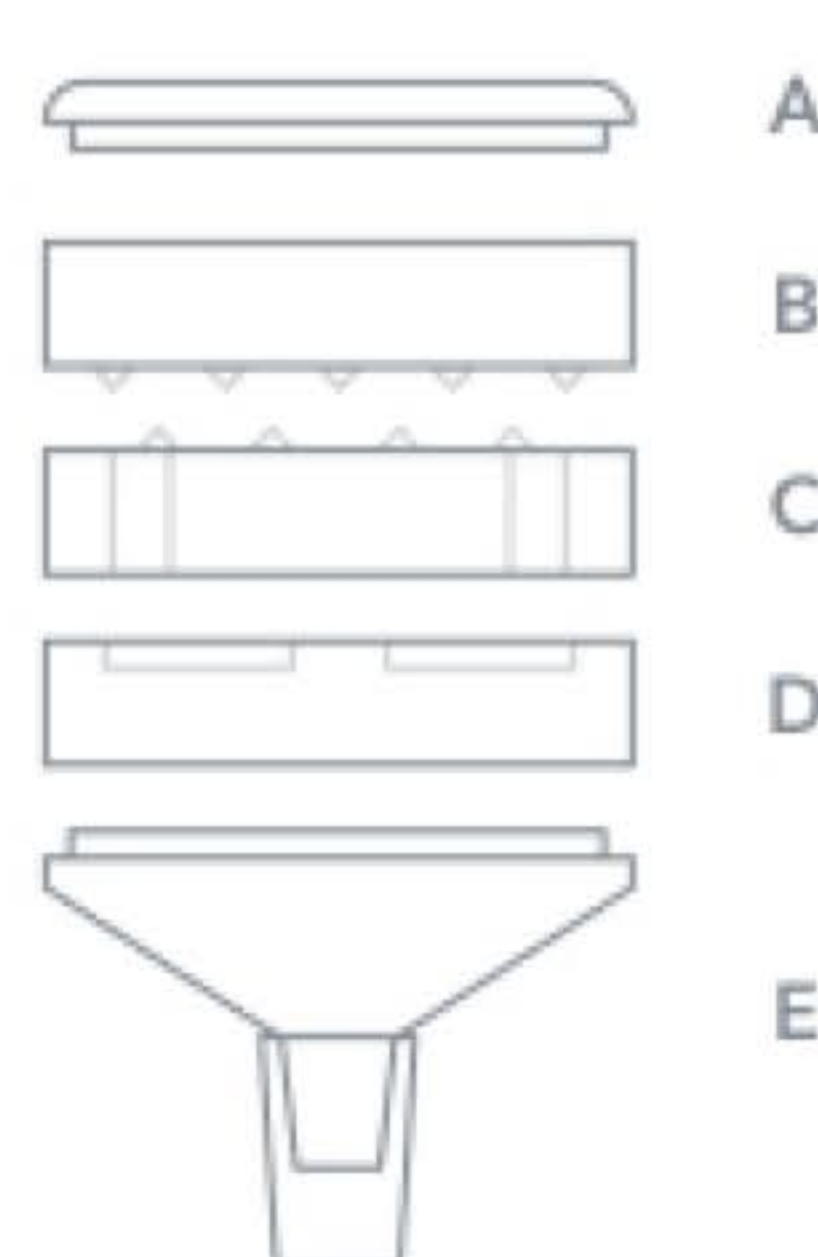

**Herb Shredder**  
Quantity: 1  
Includes:  
A. Base Storage Cover  
B. Shredder Tooth  
C. Mid Shredder  
D. Pots Tray  
E. Funnel Storage and Cap Cover

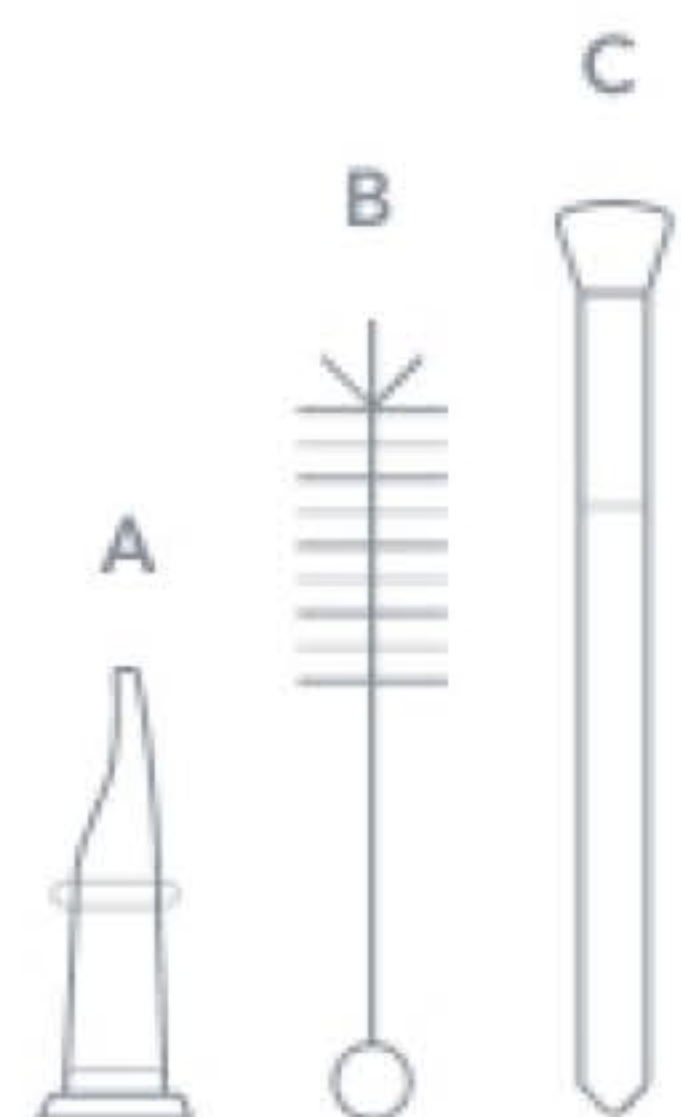

**Maintenance Kit**  
Quantity: 1  
Includes:  
Stir Pick Tool  
Cleaning Brush Tool  
Ceramic Pot Brush



**USB Cord**  
Quantity: 1  
Note: Use only this specifically included cord for Bowle/Flaske



**Manual**  
Quantity: 1

Contact Tafée's customer service when:

- The Puck and Drinkware have any operational, visible or functional defect, and/or
- Any of the listed components are not supplied in the packaging.

If you want to order more accessories (i.e. Ceramic Oven Pots, Stem, Drinkware) or consumables (i.e. Mouthpieces), please go to the website: [www.tafee.com](http://www.tafee.com)

## C. Technical Specifications

<b>Model</b>	Bowle Series II: VEE2024	Flaske
<b>Electric Connection</b>	USB Charger (Ref: Tafée UL-QC, Type: Qualcomm Quick Charge 3.0) Input: 220-110V (50-60 Hz) Output: 5.0V	
<b>Rechargeable Batteries</b>	Li-ion Polymer Cells (Output: 7.4) Bowle Series I: 750 mAh Bowle Series II: 6000 mAh	Li-ion Polymer Cell, User Replaceable 5V 3A
<b>Heating System</b>	Convection	Convection
<b>Temperature Range</b>	Bowle Series II: 260°C / 500°F	Up to 260°C / 500°F
<b>Puck Base Unit Dimensions</b>	Bowle Series II: ø77.5mm x 40mm	
<b>Dimensions with Drinkware</b>	400ml: ø90mm x 150mm 300ml: ø90mm x 115mm 250ml: ø85mm x 115mm	Flaske: 110mm x 82.5 x 28mm 246g
<b>Maximum Recommended Drinkware Fill</b>	400ml: 380ml 300ml: 280ml 250ml: 220ml	
<b>Operating Life</b>	7,000 hours	
<b>Service Life</b>	12,000 cycles	

## D. Applied Parts

The following are considered 'applied parts': Mouthpiece, Stem, Drinkware and Puck.

Before and after the operation of the Bowle®, the User touches the next parts not considered 'applied parts': Herb Shredder, Ceramic Oven Pot, Stir Pick, USB-Charger and Cord.

## E. Safety Directives and Standards



The Bowle® is fully compliant with the following European and Canadian/US regulations and standards:

- European Directive for Medical products: 93/42/CE
- Canadian Medical Devices Regulations SOR/98-282
- Class II: IEC/EN 60601-1 and IEC/EN 60601-1-11:2015
- ROHS: 2011/65/UE + 2014/1/UE to 2014/6/UE + 23014/8/UE to 2014/16/UE (included for 93/42/CE)
- Electromagnetic Compatibility: IEC/EN 60601-1-2:2007
- Electrical security: IEC 60601-1:2005/A1:2012 and EN 60601-1:2006/A1:2013
  - IEC/EN 60601-1-6: 2010/A1 and IEC 62366: 2007/A1, EN 62366:2008/A1
  - AAMI ES60601-1:2005+A1
  - CSA C22.2 #60601-1:2014Ed.3

## 02: OPERATING CONDITIONS AND DISPOSAL

### A. Operating, Storage, and Transport

The Bowle® can be set 5 different power levels. These range dynamically up to 260°C / 500°F.

Conditions	Operating	Storage & Transport
 Ambient Temperature	Minimum: -10°C (14°F) Maximum: 30°C (86°F)	Minimum: 10°C (50°F) Maximum: 20°C (68°F)
 Relative Humidity	20% to 80%	15% to 80%
 Atmospheric Pressure	700 hPa to 1060 hPa	700 hPa to 1060 hPa

### B. Disposal

At the end of its operating life or if damaged beyond repair:

- The puck, USB-charger and cord must be disposed of at recycling point for electronic and domestic products.
- The accessories and consumable parts should also be disposed of at a recycling center.

### 03: SAFETY RECOMMENDATIONS

This manual must be supplied with the Bowle. It is important and necessary to read these instructions carefully before using the Bowle®, and to keep this manual in a safe place for future reference. The latest version of this manual can be downloaded from: [www.tafee.com/support](http://www.tafee.com/support)

#### A. User Precautions

Major changes in the environment (external conditions) may cause the Bowle® to malfunction. Always protect the Puck against liquids, rain or humidity, and high temperatures, including direct sunlight.

**Note:**

Please consult your doctor or pharmacist if you have any medical concerns. It is possible that some herbs or flowers may cause allergic reactions for the user. If this occurs, it is urgently recommended to refrain from further use of such herbs and flowers.

Mouthpiece, Herb Shredder, Ceramic Oven Pots, Stir Tool and Stem are not supplied in a sterile condition.

Tafée recommends rinsing these parts in warm water and thoroughly drying before first use.

Handle with care Ceramic Oven Pots are hot surfaces that can exceed 50° C

#### B. Safety Recommendations

- The Bowle® and Flaske™ is an electronic device and should be used with caution.
- The Puck Base Unit, Stem, Herb Shredder, USB-charger, accessories and packaging material must be kept out of reach of children, animals, and persons not using or administering or undergoing aromatherapy.
- The use by children must be supervised by an adult, also the supervision of people with visual and hearing problems or other related disabilities.
- The Puck Base Unit, Herb Shredder, USB-charger, and cord must not be exposed to heavy impacts or vibrations; liquids, wet surfaces, rain, humidity; great pressures or varying pressures; or sources of heat that could damage their functions, the insulation of the USB-cord, or the external casing.
- Do not expose electrical parts or live wires and connections, as this can result in electrocution.
- Before use and during operation, the Bowle® must be placed on a stable, flat, and dry surface.
- Never place any part of the Bowle® close to flammable objects, gases or liquids at risk of explosion or ignition, sources of heat (oven, barbecue, grill or stove) and cold (refrigerator, freezer or cooler).
- Do not obstruct the air inlet of the Puck Base Unit.
- Do not touch the Ceramic Oven Pot when still hot and never leave the Bowle unattended while it is on and operational. After use, switch off and lock the device.
- To operate, the device must have good air flow; the device must never be covered by objects (blankets, pillows, clothes, etc.) while it is in use and heating up.
- Never insert or allow any foreign body, liquid to penetrate the internal structure of the Puck Base Unit, the USB-charger or USB-cord. Only the Drinkware can be in contact with liquids.
- The plug of the USB-charger is the medium to disconnect the equipment from the socket (supply mains). If there are any problems during the device operation, immediately disconnect the USB-charger from the socket.
- Before cleaning, disconnect the USB-charger from the socket or the USB-cord from the USB-charger.
- Keep Puck Base Unit powered off and stored in its package or in a place where dust and other particles are minimized as much as possible when not used for an extended period.
- Use only the USB-charger, USB-cord and accessories provided by the Tafée or sold directly by Tafée.
- If the USB-cord, USB-charger, Puck or Drinkware are damaged or faulty, don't operate the device and report the problem to Tafée's Customer Service.
- Keep the Bowle, Potter and Power Adapter away from pets (e.g. dogs, cats, hamsters, mice) and other animals which could damage the insulation of the power adapter cord.
- The Puck, USB-charger and cord must only be repaired by Tafée's Customer Repair Service.
- Never fully discharge the Puck Base Units battery. Batteries must be charged as soon as it indicates it has 25% of the battery life remaining. User must check battery status before and after every session.
- Allow breaks in between use to maintain safe and optimal operational temperature preventing overheating and risk of burns.
- Never place any part of Bowle in a Microwave or Oven.

**Note:**

The manufacturer will not be held liable for any damage or personal injury caused by improper, irresponsible, or dangerous use of the device.

### 04: INDICATIONS AND UNWANTED EFFECTS

#### A. Device Indications

The Bowle® and Flaske™ has been designed exclusively for the administration of herb and flower aromatherapy. Derivatives like e-liquids or e-cigarette juices are NOT suitable to use for vaporization with the Bowle.

Use initiation and supervision using Bowle® and natural organic herbs and flowers should be managed by a healthcare professional.

Inhalation results in the rapid absorption of the active ingredients into the blood stream within a short timeframe. Please follow the proper inhalation technique which is described in Section 5.

#### B. Potential Unwanted Effects of Aromatherapy

Unwanted effects may be caused by aromatherapy and/or by the active ingredients. The table below describes typical unwanted effects and suggests ways of resolving these issues.

Side Effects	Cause	Suggestions
Itching of the nose during the first inhalations.	Initial sensitivity of nasal membrane caused by the active ingredients or aroma temperature.	<ul style="list-style-type: none"><li>• Select a lower power level</li><li>• Exhale through the mouth, not through the nose.</li><li>• Inhale slower with less intensity.</li><li>• Itching should subside after a few seconds. If not consider the herb or flower choice may be incompatible for the user.</li></ul>
Dryness in the throat or mouth.	Dryness and temperature of the vapor.	<ul style="list-style-type: none"><li>• Select a lower power level</li><li>• Inhale slower with less intensity.</li><li>• Drink liquid regularly from the Glassware to moisten the mucous membrane of the mouth and throat.</li></ul>
Coughing and lung irritation.	Too large inhalation of vapor resulting from intensity and length of inhalation.	<ul style="list-style-type: none"><li>• Inhale slower with less intensity.</li><li>• Select a power level.</li><li>• Aim to not exhale sooner after inhalation to avoid extended holding of breath.</li></ul>

The inhalation process may cause fatigue, breathlessness, and dizziness. If the User experiences any of these effects, the User should:

- increase the time in-between inhalations
- use the diaphragm to inhale slow and deep
- drink water often to moisten mouth and throat

If these effects continue, stop using Bowle immediately and contact your health care provider as soon as possible.

#### C. Contraindications

Respiratory diseases can be a contraindication for the inhaled route of administration.

## 05: OPERATION OF THE BOWLE AND FLASKE

### A. Recommendations

- Use the device indoors in a dry and well-ventilated room.
- Always place the Bowle® on a flat balanced surface.
- Never place the device close to a hot or wet surface, or flammable gases or materials.
- After charging, unplug the USB-charger from the power wall socket.
- The Puck Base Unit must only be recharged with the supplied Charger.
- Never charge Bowle or Flaske with any other charger other than the recommended 5V 3A charger.
- The Puck Base Unit should only be separated from the Drinkware when the Drinkware is completely empty and without any liquid in the Drinkware. Failure to do so may result in damage to the Puck Base Unit and the Drinkware.
- Liquid should only be poured into the Drinkware when the Drinkware has already been attached to the Puck Base Unit.
- Never drink or try to drink the liquid contained in the Drinkware while inhaling. Attempting to drink while inhaling will expose you to a choking hazard.
- Only drink the liquid contained within the Drinkware around areas of the Drinkware that are not in contact with the Stem Mouthpiece.
- Never pour liquid or force liquid inside the Stem Mouthpiece.
- Never consume alcoholic beverages in the Drinkware. Doing so may damage Bowle and void your warranty.
- Never use the Bowle or Flaske outside private residences or designated use spaces where permitted.
- Never use Bowle or Flaske in the preceding 6 hours prior to operating any machinery or equipment.
- Never use Bowle or Flaske in the preceding 6 hours prior to operating a Motor vehicle, aircraft, water vessel or prior to being in command of any other transportation or leisure craft.

### B. Power and Charging

The User must charge Bowle and Flaske on first use. The Puck Base Unit which houses the electronic internals and oven of Bowle ships in a 'locked' state and must be plugged in to be 'unlocked' and fully charge before first use.

To charge the Puck Base Unit, the User must plug the USB-charger to the mains and connect the cord to the USB port of the Puck. Take care to plug the USB Cable properly on top the Puck Base Unit making sure to match the port at the right angle as shown in the images. The battery charging level is indicated with BLUE LEDs.

A fully charged battery is indicated with all LEDs flashing blue simultaneously and switching off their display when plugged in to charge. It could take up to 1 hour to fully charge the Puck Base Unit.

#### Note:

**Avoid fully depleting the battery of the puck base unit to ensure a longer better performing battery for the operational lifetime of Bowle.**

It is important to always check the battery level before and after every session. The Puck Base Unit should never be allowed to completely be discharged of battery power. Batteries must be re-charged often when it indicates it has 25% of the battery capacity remaining. It is highly recommended to ensure the battery is charged to at least 75% of its capacity or above before use.



### Bowle

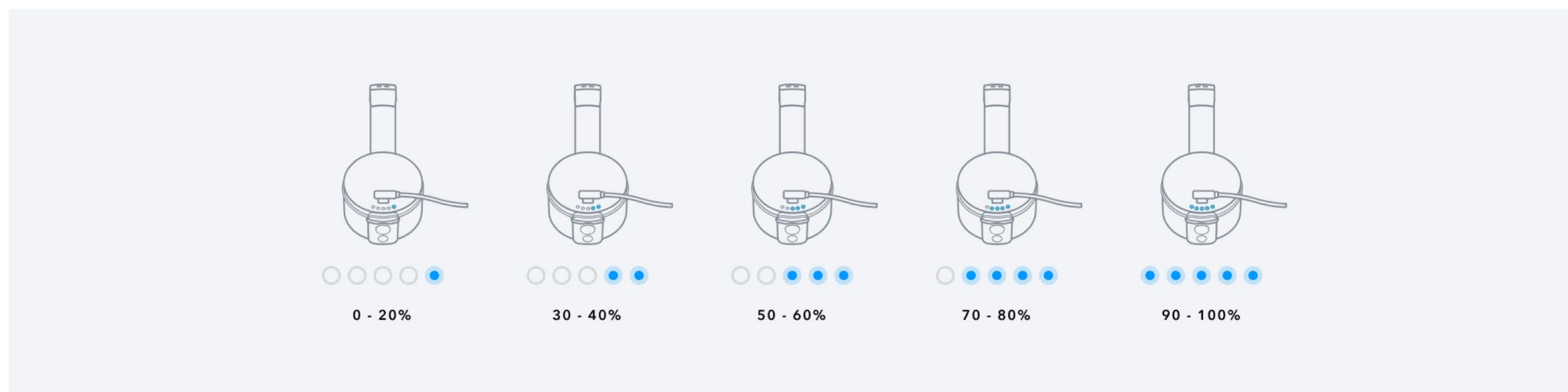

When the User plugs in the Puck to charge, its battery charging level is indicated with pulsing BLUE LEDs. (Depending on the state in which the Puck Base unit is plugged in to charge, it could take up to 10 seconds for Bowle to indicate its charging status).

### C. Lights, Buttons, and Port

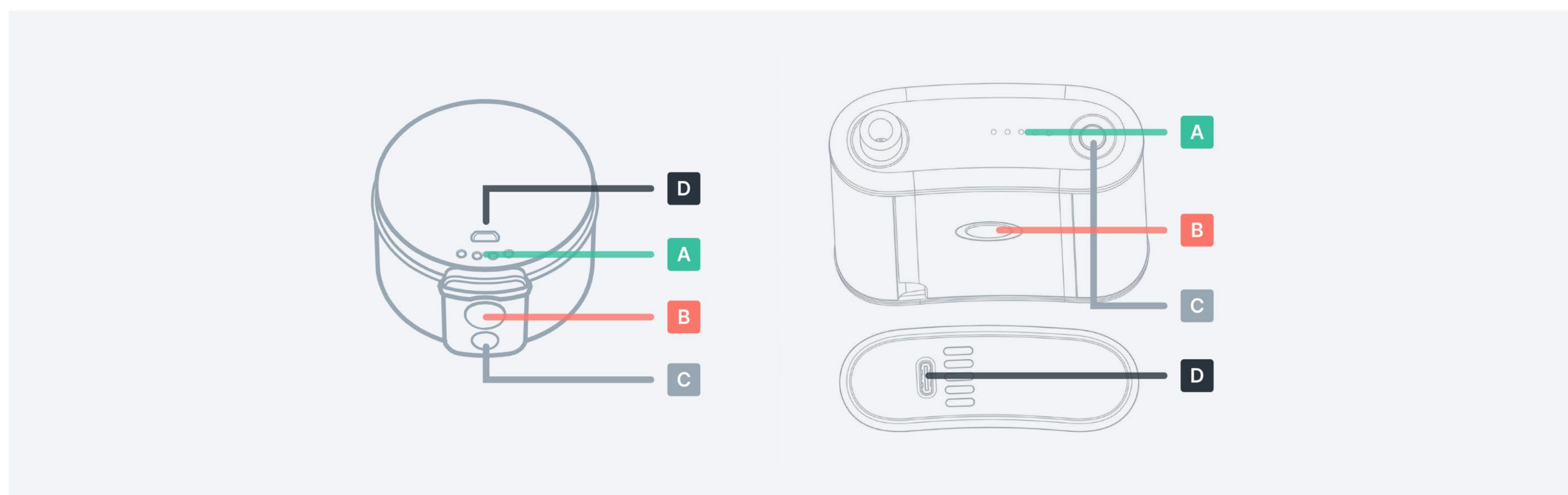

Label	Component
<b>A</b>	<ul style="list-style-type: none"> <li><span style="color: blue;">●</span> <span style="color: green;">●</span> LED Solid State</li> <li><span style="color: blue; border: 1px solid blue; border-radius: 50%; padding: 2px;">●</span> <span style="color: green; border: 1px solid green; border-radius: 50%; padding: 2px;">●</span> LED Pulsing State</li> <li><span style="color: blue; border: 1px dashed blue; border-radius: 50%; padding: 2px;">●</span> <span style="color: green; border: 1px dashed green; border-radius: 50%; padding: 2px;">●</span> LED Flashing State</li> </ul>

<b>B</b>	Fire Button (Large)
----------	---------------------

<b>C</b>	Power Level Button (Small)
----------	----------------------------

Function	Method
Lock/Unlock	Click and release <b>B</b> 3 times (very fast).
Start (when unlocked)	Click and release <b>B</b> 1 times (very fast).
Change Power Level	Click and release Small <b>C</b> 1 time.
Check Battery Level	Click and release <b>B</b> + <b>C</b> together.

**Note:**

Never activate the Start/Fire button **B** without inhaling. Doing so will damage the device and void your warranty.

### D. Selecting the Power Level

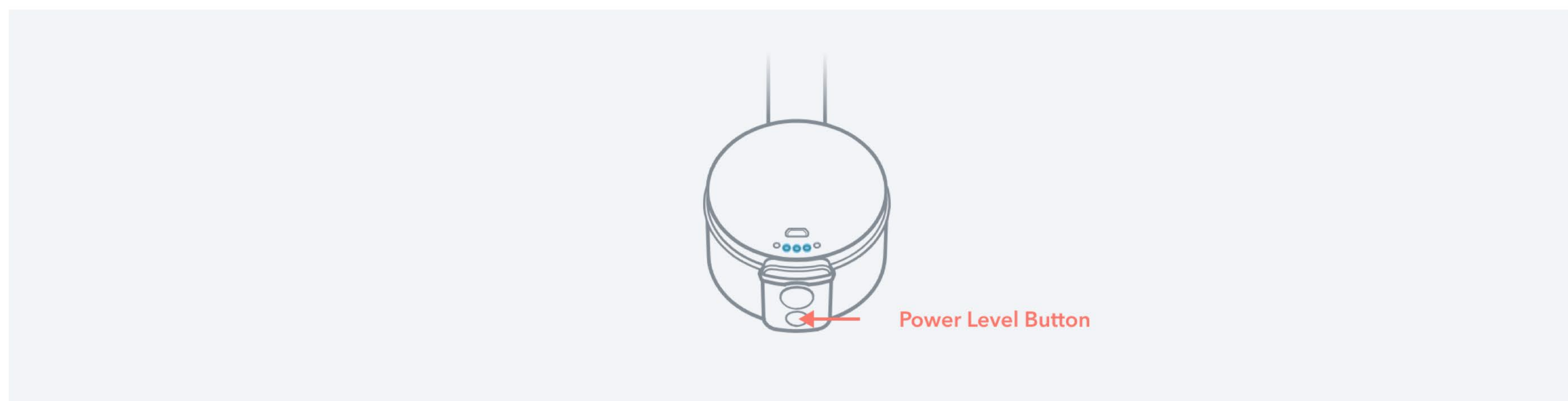

Click and release the Power Level button (small button on bottom) to select User desired Power Level. Each single button click cycles through 1 incremental Power Level, each of which represent dynamically preset temp settings:

<span style="color: blue;">●</span> ○ ○ ○ ○ ○	<b>Soft</b> Invisible aerosol and tasteful wisps of aroma
<span style="color: blue;">●</span> <span style="color: blue;">●</span> ○ ○ ○ ○	<b>Low</b> Light aerosol, lots of aromatic taste
<span style="color: blue;">●</span> <span style="color: blue;">●</span> <span style="color: blue;">●</span> ○ ○ ○	<b>Medium</b> Packs power for more aerosol
<span style="color: blue;">●</span> <span style="color: blue;">●</span> <span style="color: blue;">●</span> <span style="color: blue;">●</span> ○	<b>High</b> Heavy aerosol, heavy aroma
<span style="color: blue;">●</span> <span style="color: blue;">●</span> <span style="color: blue;">●</span> <span style="color: blue;">●</span> <span style="color: blue;">●</span>	<b>Max</b> Vaporize highly concentrated organic mediums

**Note:**

Avoid fully depleting the battery of the puck base unit to ensure a longer better performing battery for the operational lifetime of Bowle.

#### Usage

The ingenious technology that was applied to the development of Bowle and Flaske, makes for easy and quick usage. The user simply places their herbs or loose leaf of choice in the shredding chamber of the Potter®. (See 06 Operation of Potter Herb Shredder) With a few quick twists of the Potter®, the contents are shredded into ceramic pots and ready to use. The pot is placed in the stem and the stem is inserted in the puck. The user then pushes the start button and inhales the organic compounds via aerosol at the top of the stem.

Optionally available drinkware seamlessly allows for the functionally perfect pairing of beverage to moisten airways or quench thirst as is a natural co-habit during aromatherapy.

#### Sustainable Tolerance Usage Guideline

Less is more in Bowle and Flaske. The ceramic pot micro dosing system was designed to help modulate use and ensure your continued sustainable well being. It is never sustainable to risk addiction to anything. So we have devised a guideline to help make smart choices regarding managing tolerance over extended periods of use.

- 1 Try to have no more than 3 sessions a day.
- 2 Endeavor to remain within lower power settings and slowly work your way up.
- 3 Avoid consumption of alcoholic beverages during aromatherapy.
- 4 Take breaks and stop use during periods of any cardiovascular health illness or discomfort. Ensure your source of aromatherapy natural herbs is trustworthy.
- 5 Take note of and avoid organic compounds and natural substances that may cause irritation.

## Good Battery Habits

A few tips to get maximum use per charge and good battery habits.

- 1 Use the Press and Hold Fire Button operation method over the Press and Release method. With the Press and Hold method.
- 2 Continue to inhale aerosol for a few seconds even after releasing the "Fire Button" as aerosol can still be produced even after the oven shuts down when the fire button is released. This increases efficiency of both material consumed and reduces battery life used per inhalation.
- 3 Charge Bowle after every second session and endeavor to avoid completely depleting your batteries.

## E. Using Bowle with Drinkware (Optional)

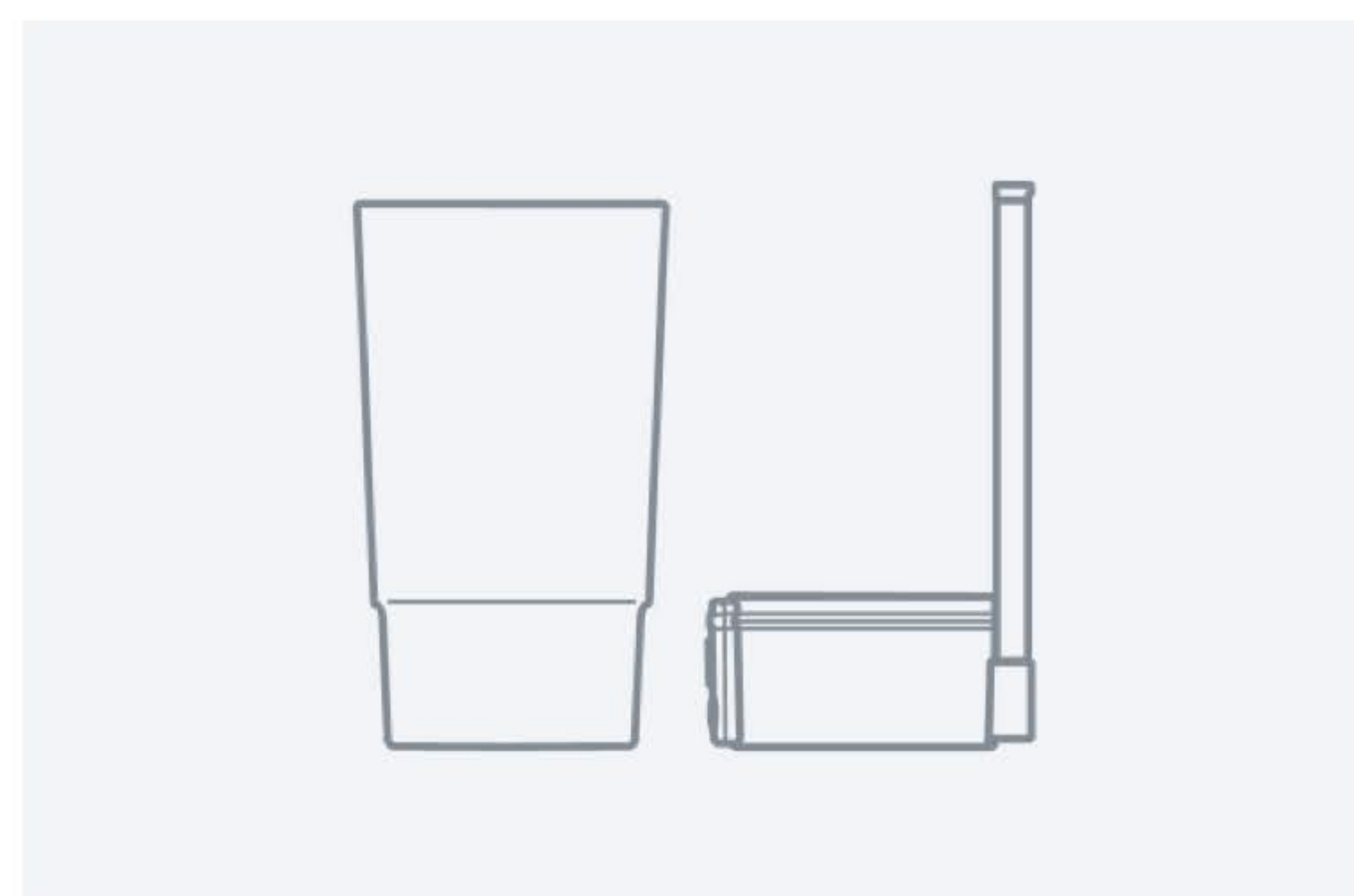

1 of 4

- Starting with a drinkware

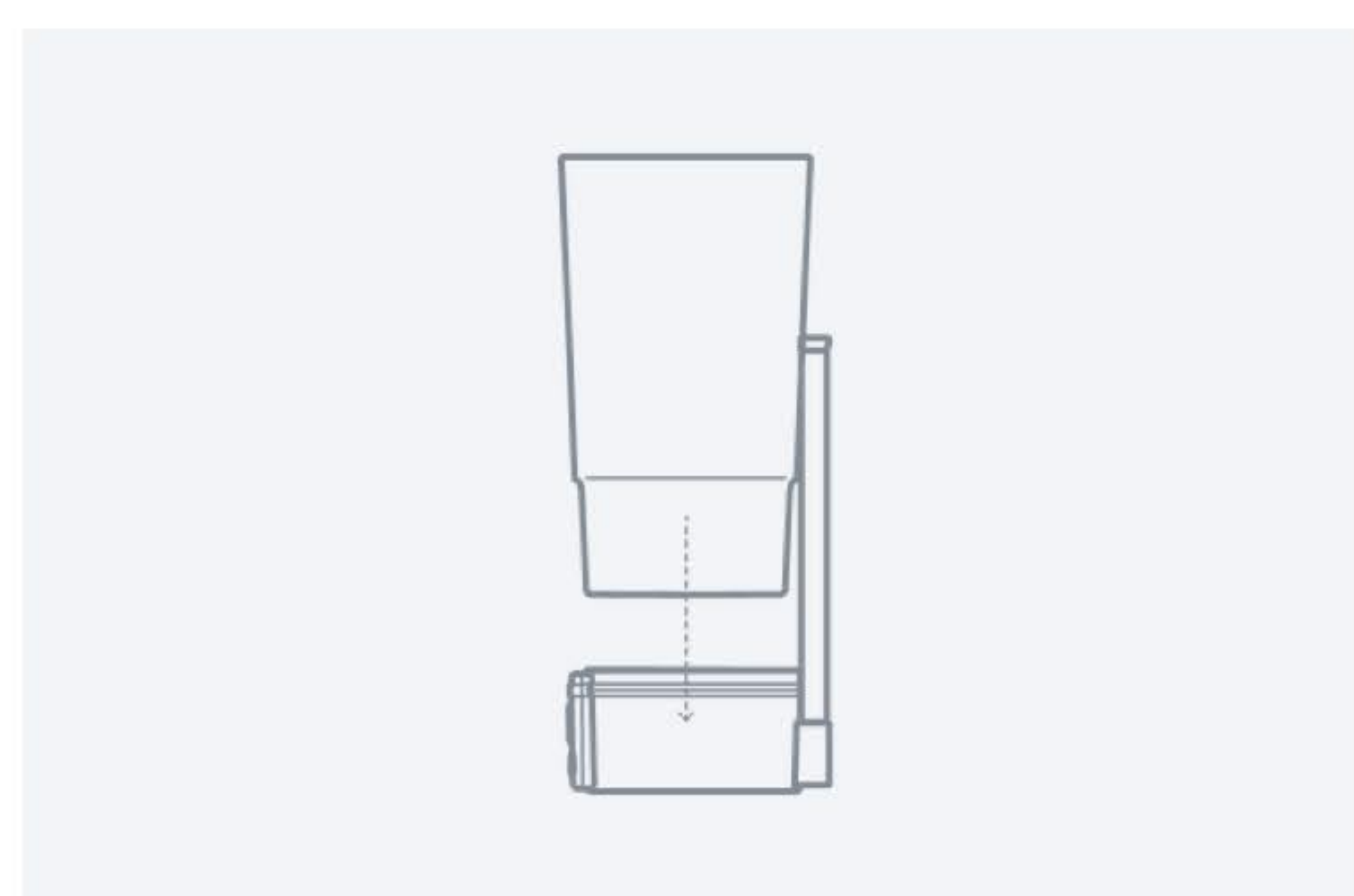

2 of 4

- Align the ridged portion of the Drinkware to the assembled Puck and Stem.

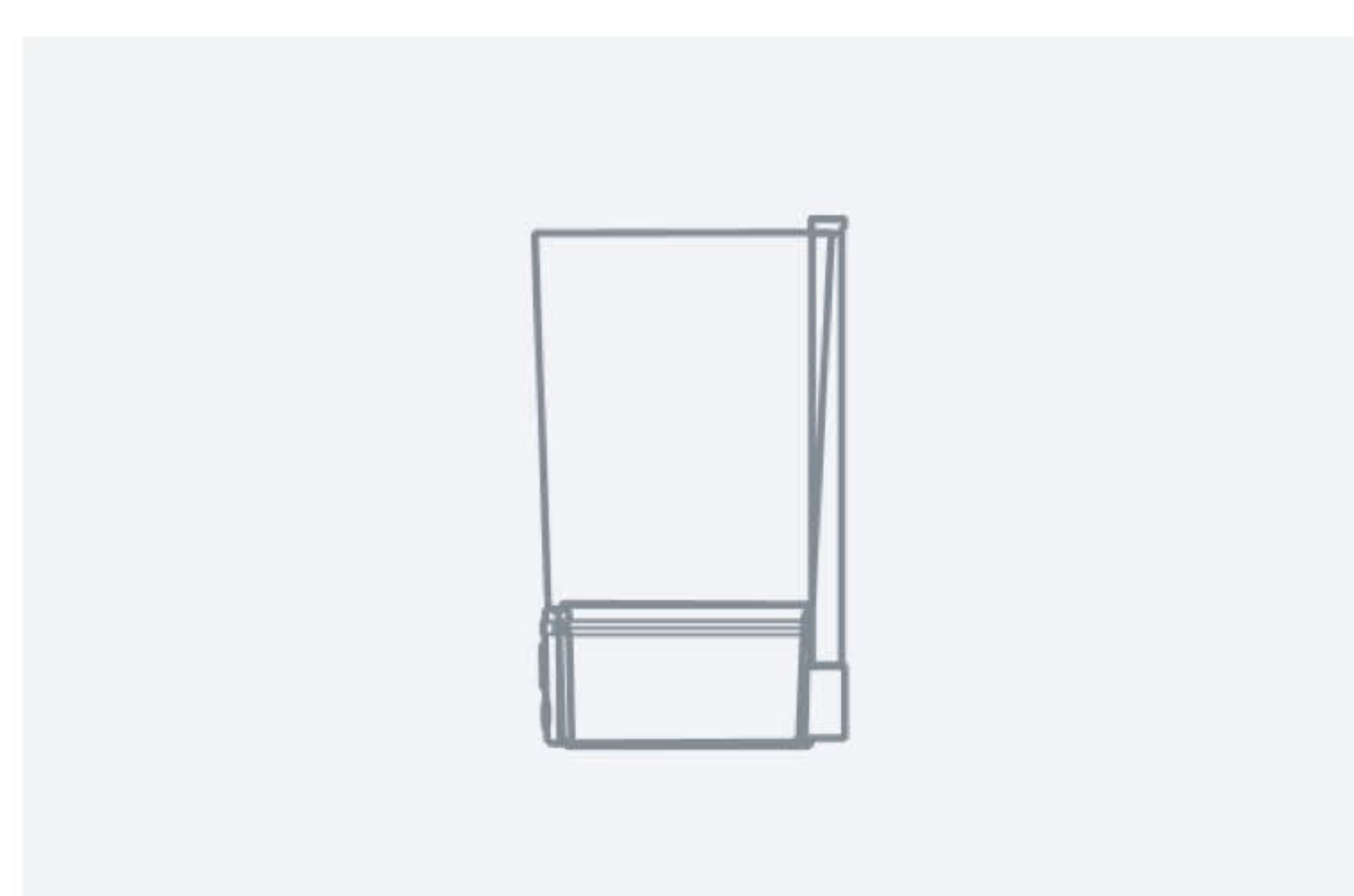

3 of 4

- Slide the assembled Puck and Stem into the aligned hollow ridge until it is firmly snugged in place at the base of the Drinkware.
- Alternatively, you may place the Drinkware on top of the assembled Puck and Stem at rest on a flat surface.
- The engineered fit ensures the Puck stays attached to the Drinkware.



4 of 4

- Pour drinking water or non-alcoholic beverage into the glass. Never pour more than 3 quarters of the capacity (only Drinkware mug handle (sold separately) may be used for hot drinks).

- **Note:** Always remember to mount Drinkware on Puck Base Unit prior to filling the glass with drinking water or non-alcoholic beverage.

### Note:

Avoid drinking from the Drinkware around the Stem or mouthpiece of the Stem areas.

Image Shown below indicates ideal areas from which the User should drink from around the Drinkware.

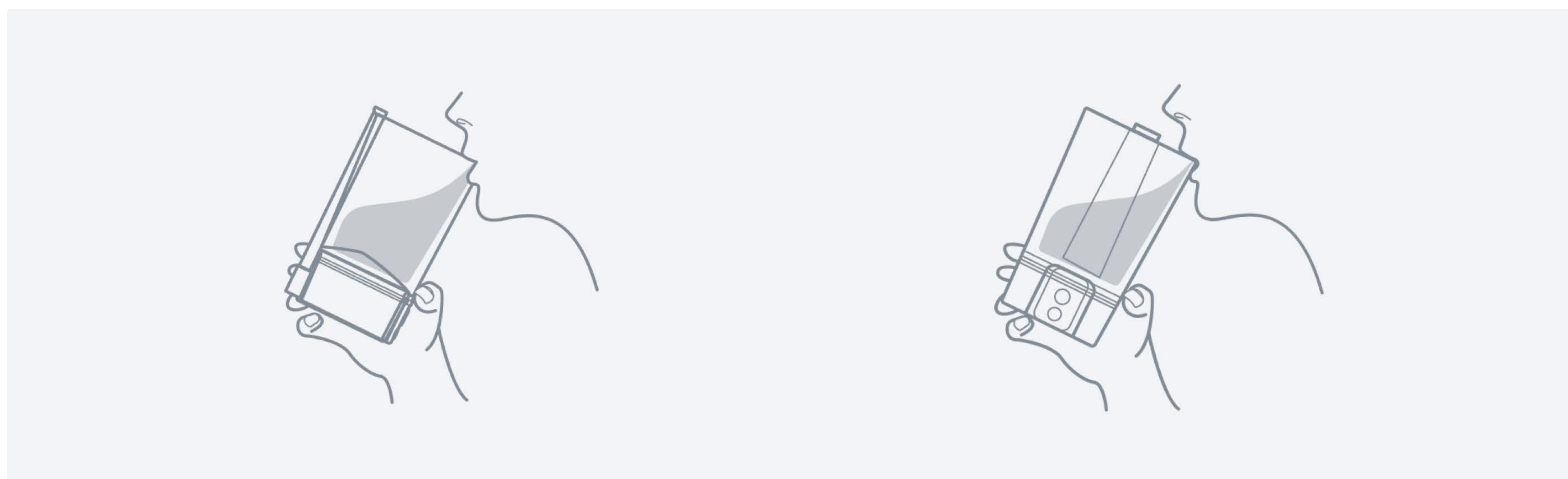

Image Shown below indicates the stem mouthpiece is the only area designated for inhalation from Bowle.



## Detaching the Drinkware: Option 1

Use this exact method to detach the Drinkware from the Puck Base Unit smoothly with ease.

- First Lock the Puck Base Unit with the 3 quick clicks of the Fire Button. (See (J) Locking and Power Off the Puck Base Unit).
- Empty the contents of the Drinkware.
- Hold Bowle firmly in one hand.
- PUSH DOWN and OUT" around the lowest protruding edge of the Stem and the Puck Base Unit away from the Drinkware. (The lowest protruding edge of the Stem is the bottom portion of the flat back of the Stem aligned with the mouthpiece).
- Pull down the opposite end of the Stem, beneath the Temp. Select button, towards the Drinkware to wiggle the snug fit loosened further.
- Repeat the 'PUSH DOWN and OUT' and pull down the opposite end of the Stem towards the Drinkware 'detachment motions' to continue to dislodge the fit a few more times until sufficiently loosened enough to separate the Drinkware away from the Puck Base Unit and Stem without resistance.

### Detaching the Drinkware: Option 2

- Simply detach the stem
- Separate the puck from the bottom of the drinkware by way of sliding out of drinkware base. (Do this with thumb or index finger gripping the Stem slot area and with opposite finger at the base of the buttons on the opposite side of the puck).

#### Note:

Make sure Puck is powered down, and has not been in operation the preceding 4 minutes before separating this way.

Do not use the Stem to detach the Drinkware from the Puck Base Unit. Doing so may damage the calibrated fit of your Stem, significantly reducing its performance

#### Note:

Alternatively, the user may first detach the Stem and then separate the Drinkware from the Puck Base Unit by inserting the thumb finger into the oven slot of the Puck Base Unit to wiggle it loose from its fit within the base of the Drinkware

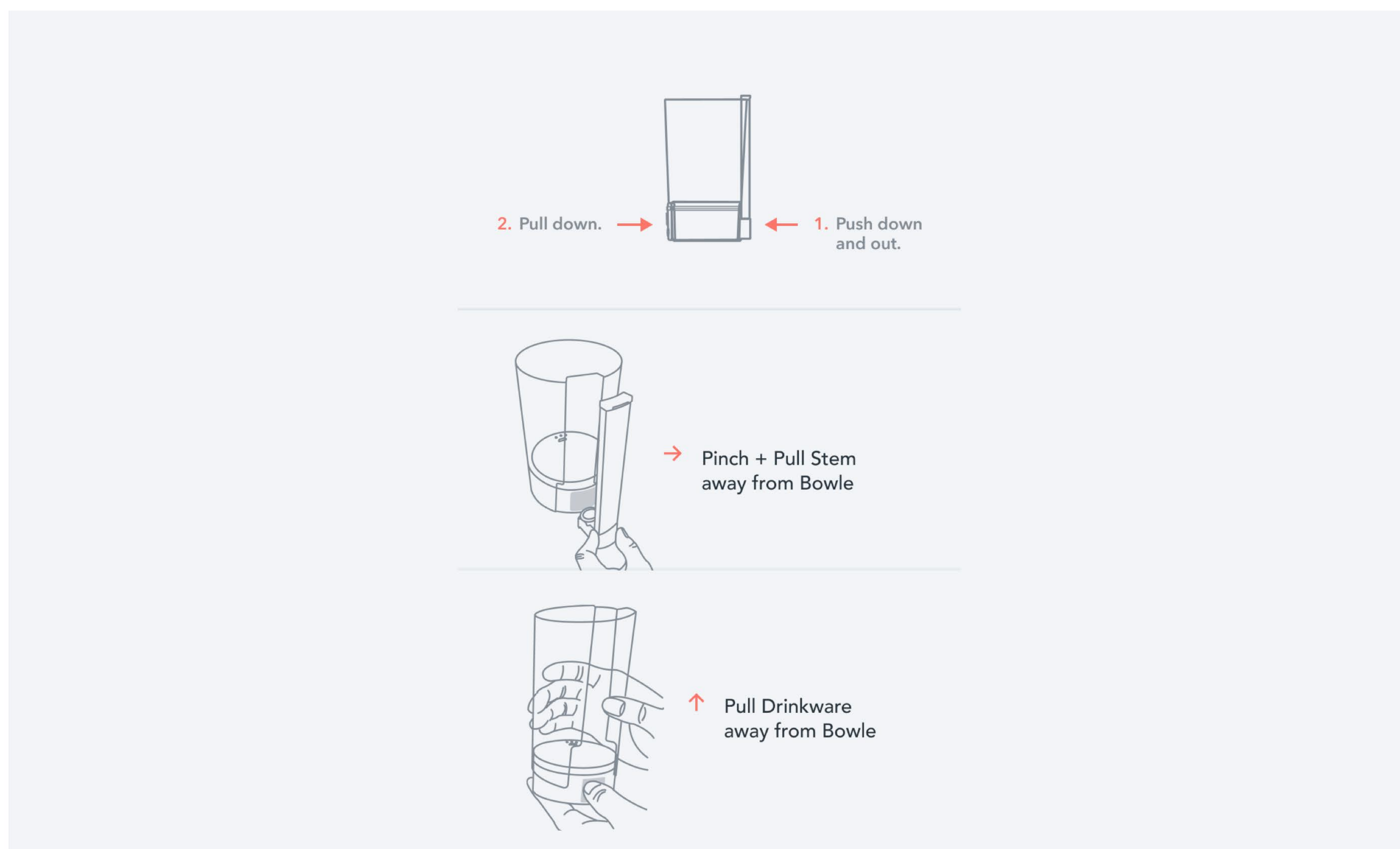

### F. Unlocking and Power On for Use

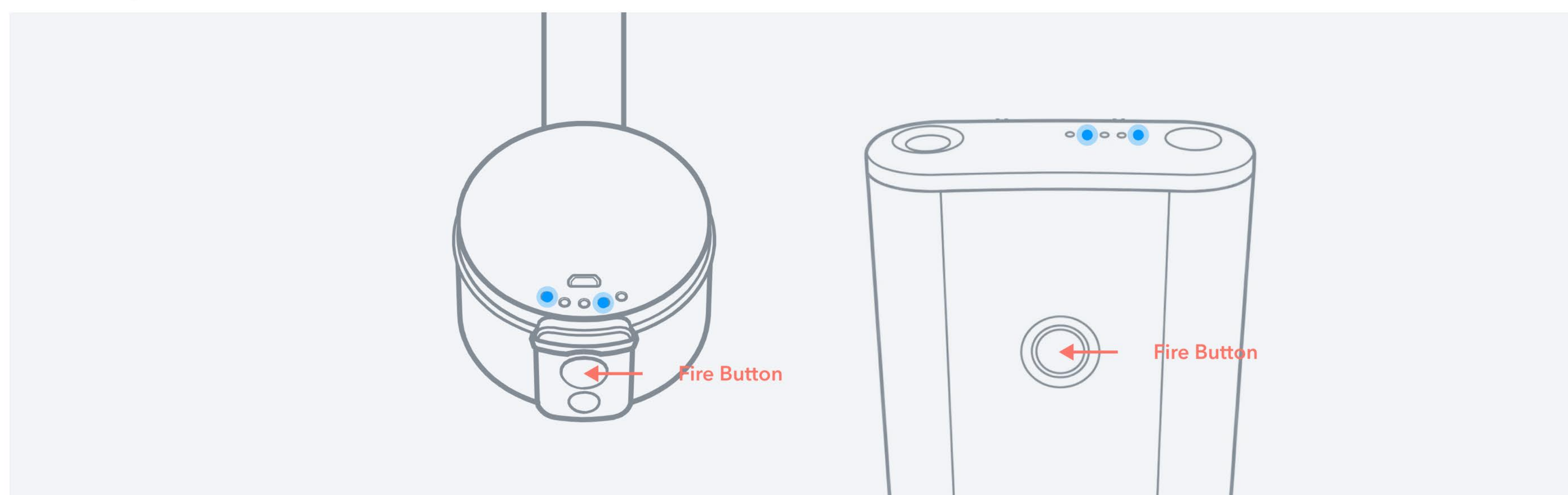

#### Note:

If the device is activated and indicates a green LED at the selected power level for longer than 3 seconds, without the user immediately inhaling or after stopping inhaling press the start **B** fire button immediately to stop the device. If this behavior displays this event multiple times in one session, please contact [info@tafee.com](mailto:info@tafee.com) for support.

To Unlock and Power ON, User should click the Fire button 3 or more times with less than 0.3 second gap between each click.

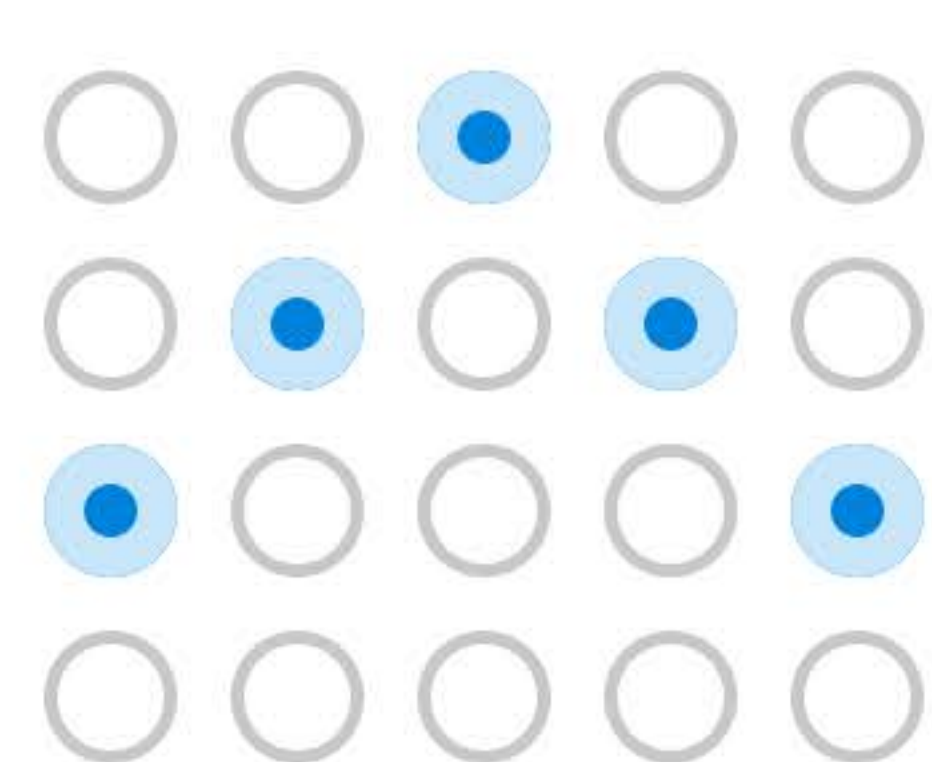

Light Blue LEDs comes on in 0.5 seconds, two inner LEDs flash blue once, then two outer LEDs flash blue, the flashing sequence repeats once more, indicating the Puck Base Unit is unlocked and ready to operate.

#### Note:

After Unlocking: Blue LEDs will turn on and pulse. The number of pulsing LED's indicate the last used and current power level setting. If last used power level was set at power level 2, then 2 LEDs will fade in and out.

## G. Checking the Battery Level

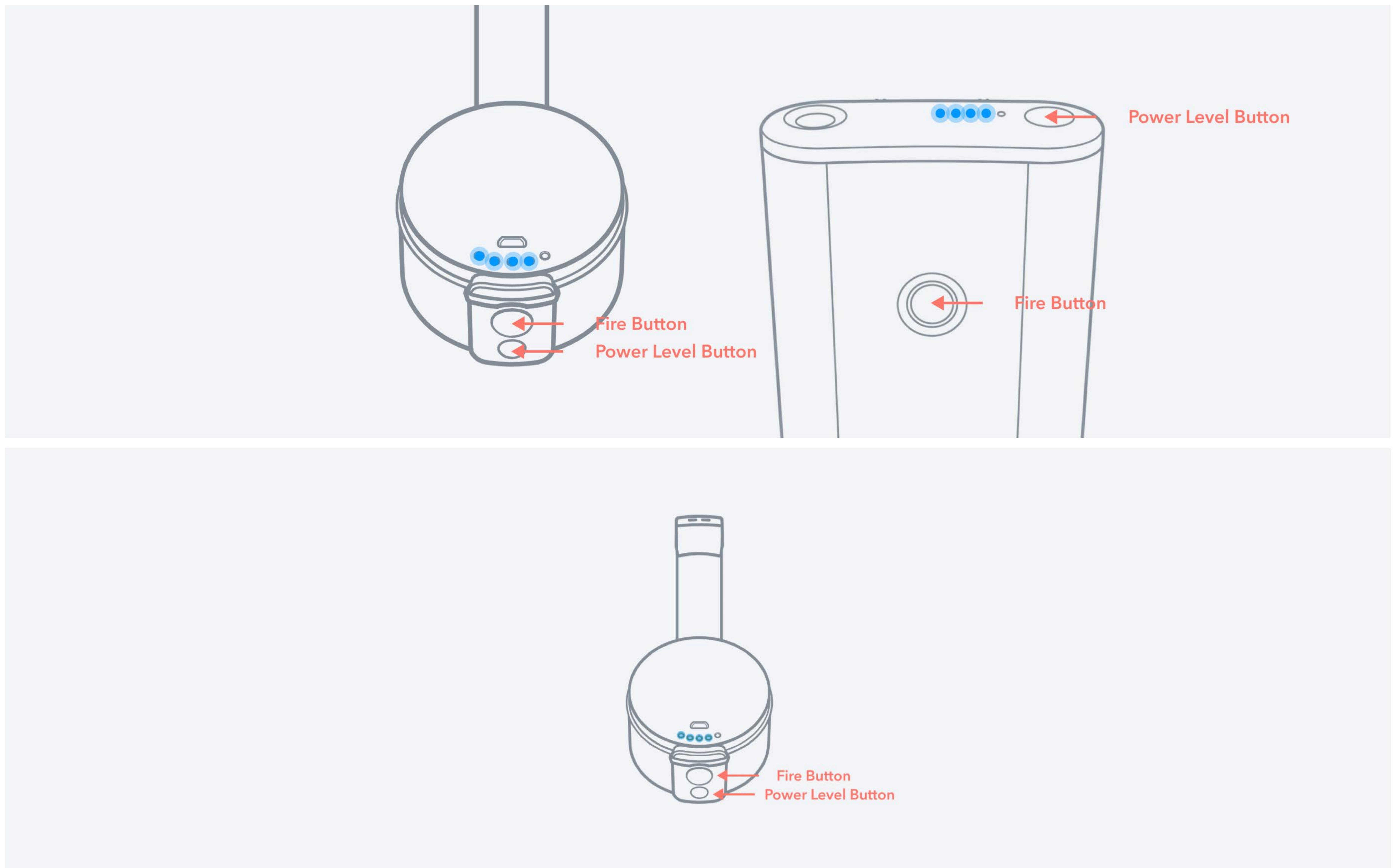

Click and release both the Fire and Power Level Button together at once to check the Puck Base Unit battery level.

For Bowle and Bowle Series II, each Deep Blue LED indicates the battery power level of 20-25%. If 2 Blue LEDs are lit after Clicking and releasing both the Fire and Power Buttons together once to check the battery level, that indicates a battery level of 40-50%. 3 Blue LEDs indicate 60-75%. , 4 Blue LEDs indicate 80% in Bowle Series II, and 100% in Bowle, 5 Blue LEDs indicate 90-100% in Bowle Series II.

### Bowle Series II



90 - 100%



70 - 80%



50 - 60%



30 - 40%



0 - 20%

When the battery level completely depletes, the puck indicates lack of power through quick, sequential flashes of each AQUA BLUE LED lights.

#### Note:

**Tafée Recommends: To maintain power for optimum performance, recharge Bowle after every 4 - 6 Ceramic Oven Pot sessions.**

#### Note:

**Avoid depleting the battery of the Puck Base Unit to ensure a longer better performing battery for the operational lifetime of Bowle.**

It is important to always check the battery level before and after every session. The Puck Base Unit should never be allowed to completely be discharged of battery power. Batteries must be re-charged often when it indicates it has 25% of the battery capacity remaining. It is highly recommended to ensure the battery is charged to at least 75% of its capacity or above before use.

## H. Stem: Assembly and Loading

### Note:

Stem ships preassembled and attached in the oven slot.

In order to begin an aromatherapy session, the user must load the Ceramic Oven Pot with the natural organic herbs of choice. Potter™, is the herb shredding system designed by Tafée specifically to granulate organic herbs dispersed into Ceramic Oven Pots for use in Bowle.

Please see 06 — Operation of Potter™ Herb Shredder to operate the optionally supplied shredder prior to loading the Ceramic Oven Pot into the Stem.

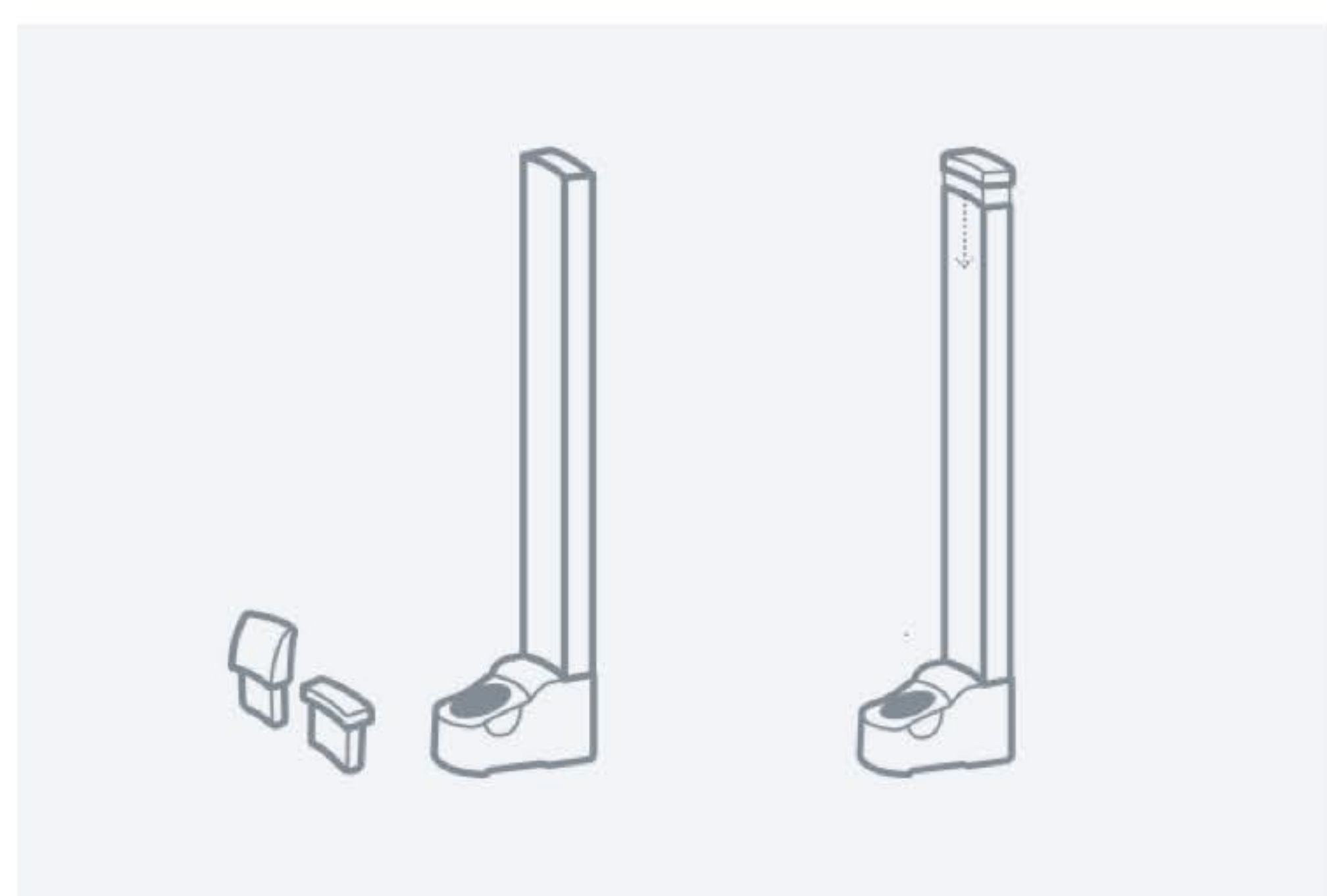

#### 1 of 4

- Starting with a disassembled Stem, insert the flat or tall Mouthpiece at the top of the Stem1.

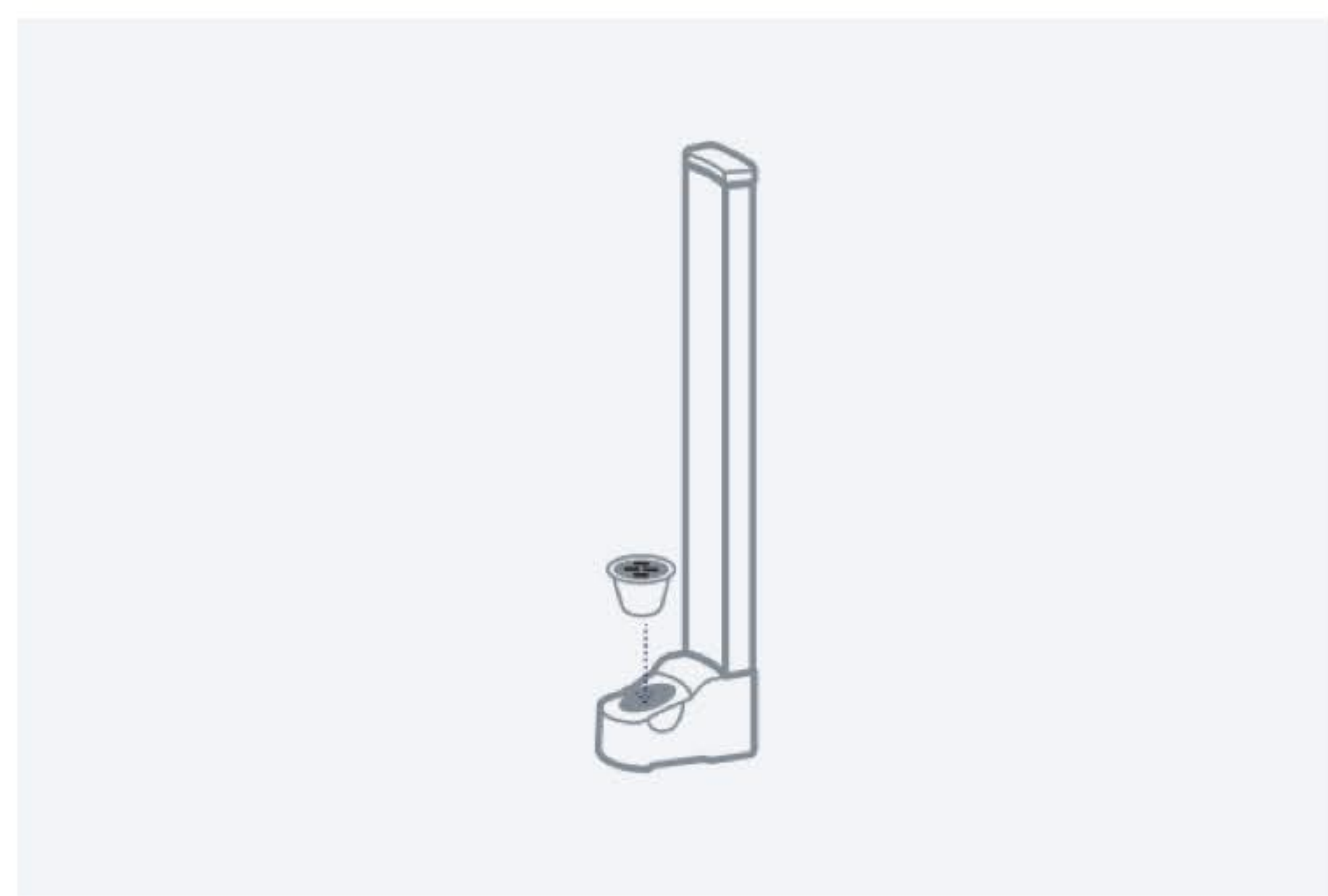

#### 2 of 4

- Place one Ceramic Oven Pot in the Stem slot located at the protruding base of the Stem2.

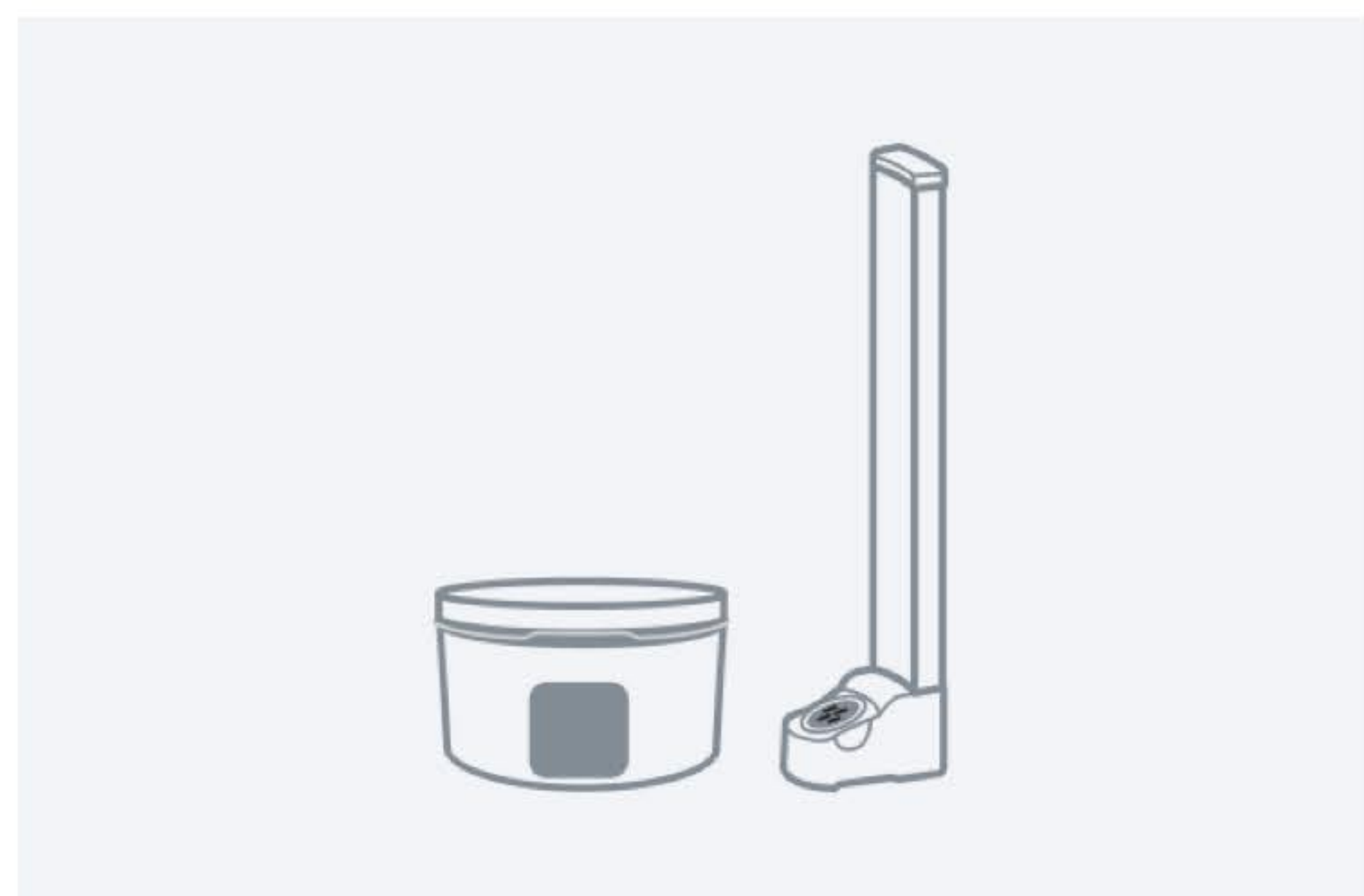

#### 3 of 4

- Attach the Stem to the Puck Base Unit by inserting the protruding base of the Stem in the Oven Slot of the Puck Base Unit.
- \* The Oven Slot is located at the back of the Puck Base Unit.



#### 4 of 4

- Push firmly at the base of the Stem until a click is heard.
- The click confirms the Ceramic Oven Pot is secured fitted and snug with the Oven.



#### Optional

- To use Bowle with drinkware, place supplied drinkware unit on Bowle before pouring in your drink of choice.

### Detaching the Stem

Use this exact method to detach the Stem from the Puck Base Unit smoothly with ease.

- Hold Bowle firmly in one hand and/or rested on a flat surface.
- 'PINCH OUT' the lowest protruding edge of the Stem from the Puck Base Unit. (The lowest protruding edge of the Stem is the bottom portion of the flat back of the Stem).
- Do this 'PINCH OUT' detachment procedure with both the index and thumb fingers, using the walls of the Puck Base Unit in contact with the tip of the index and thumb fingers as support for separation/detaching the Stem.
- Using the 'PINCH OUT' method guarantees, a smooth Stem detachment and prevents the contents of the Ceramic Oven Pot from displacement. It also protects the contents of the Drinkware from displacement avoiding spills in case of use with the Drinkware attachment.

### Note:

Do not pull the Stem to detach it from the Puck Base Unit from any other location. Doing so may damage the calibrated fit of the Stem significantly reducing its performance.

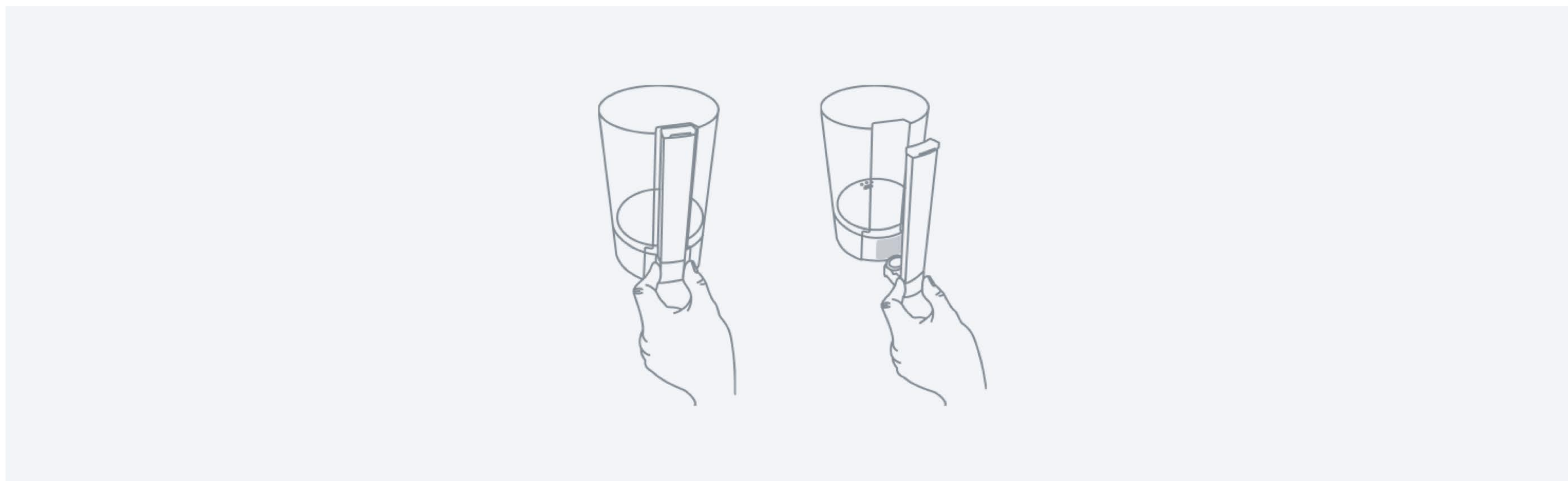

## I. Inhalation Technique

To hold Bowle properly for operation and use. The user must have Bowle resting in preferred hand with thumb finger resting on lower base of the Stem, the Mouthpiece exactly at the users 6 o'clock, with the index or middle finger on the opposite side of Bowle, softly resting by either the Fire or Power Level select button. If help correctly, it must feel very easy and comfortable to bring the Bowle and mouthpiece upwards at a low angle towards the users mouth for convenience of use.

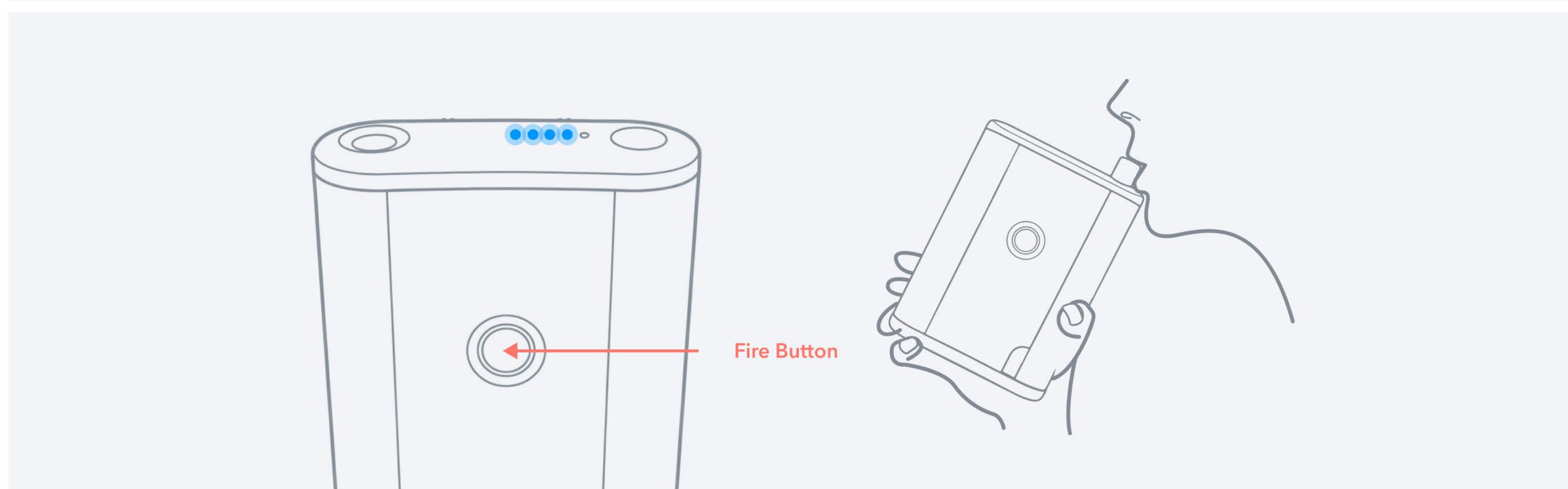
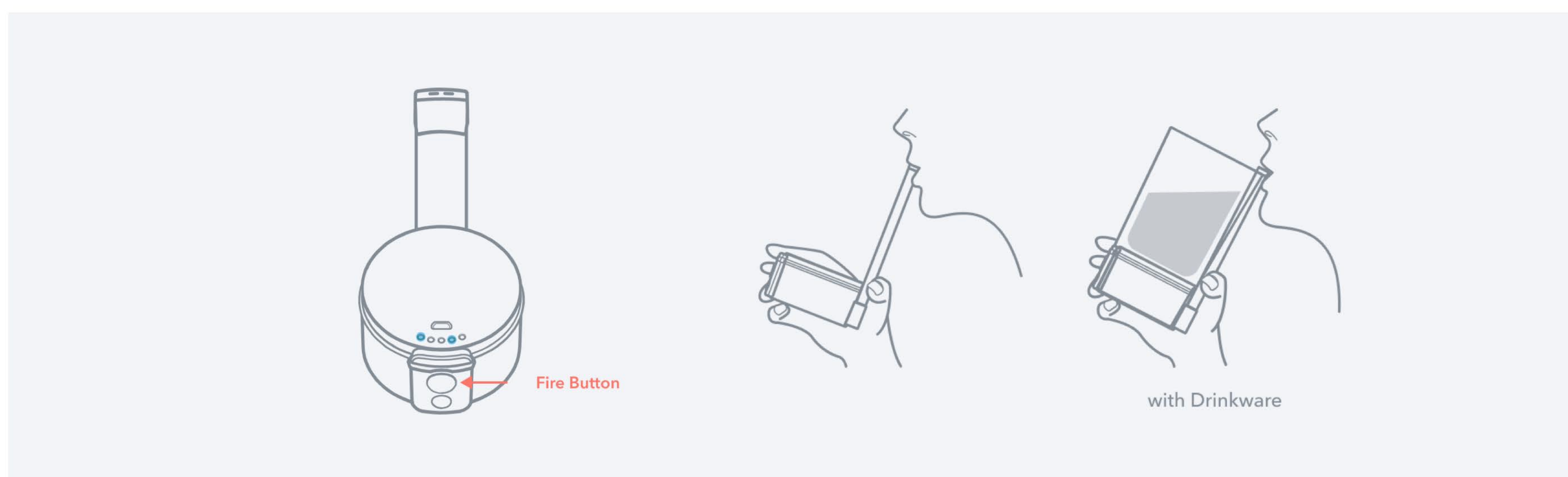

After selecting the desired power level with the Power Level select button **C** (small lower button), click and release the Fire button **B** (large top button) once.

The pulsing blue LEDs will turn solid blue as the oven spools up.



**Note:**  
If the device is on stand-by and not indicating pulsing LED's, user will have to Click the Fire Button once to first to wake Bowle up and once again to activate the oven for use.

Once the oven is up to temperature, the LEDs turn solid green.



The User should immediately begin inhalation orally via the Mouthpiece.

Upon conclusion of inhalation, Bowle will return to ready mode with the oven on standby. To inhale again, user must click and release the Fire button **B** for the oven to spool up and indicate green LEDs to then begin inhalation.

During use bring Bowle up to your lips, (Do not drop your head down to use Bowle) It should feel comfortable holding the stem up to your lips, in a natural position like at an angle like drinking from a traditional drinkware.

Certain users may prefer the alternate mouthpiece (provided in your kit) to the default mouthpiece

The tall mouthpiece is more ergonomic and makes for longer deeper inhalation.

The flat mouthpiece is more aesthetic and provides a different experience in dynamic volume inhaled in use.

If the User does not orally inhale from the Mouthpiece immediately after the oven reaches its power level setting, the oven will spool down into standby indicated by Light Blue pulsing LED's.

To resume use, the User must again press and release the Fire button to spool the oven up. Begin oral inhalation as soon as the LED's turn Green.

**Note:**  
Do not click and release the fire button (start button) without immediately inhaling after the device turns green. Doing so repeatedly will damage Bowle and invalidate your warranty.  
Always lock your device with three quick clicks of the start **B** button when not in use. This must be done to prevent accidentally activating the device repeatedly while in transport.

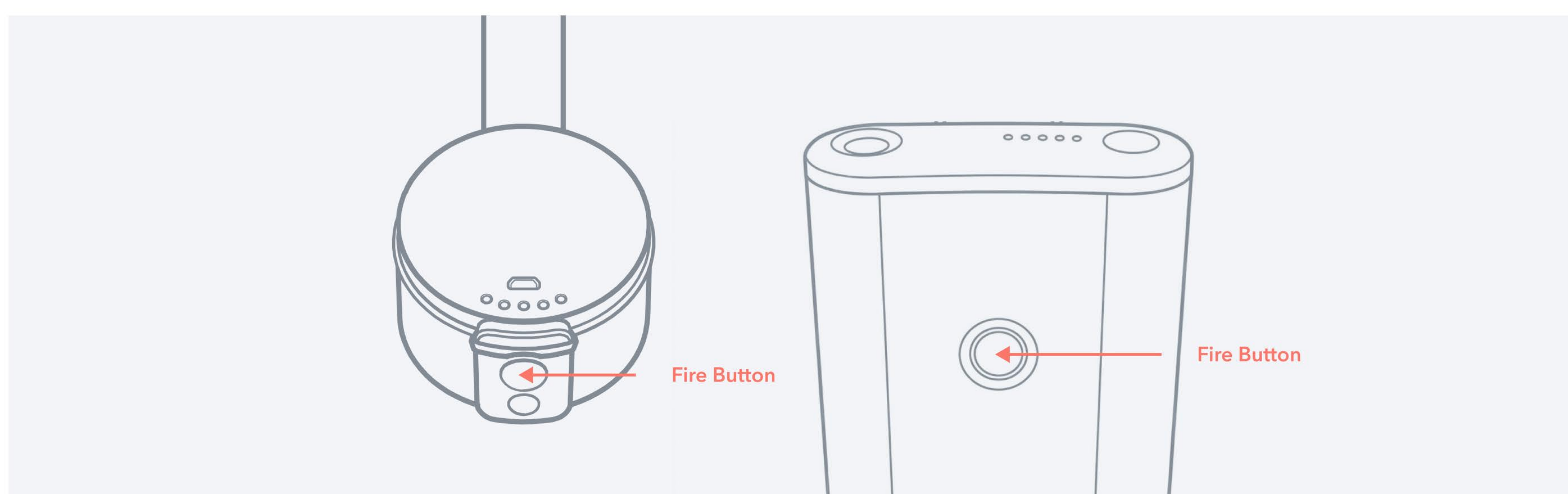

Only click and release the Fire button when the User is ready to inhale again.

**Note:**  
Tafée recommends stirring the contents of the Ceramic Oven Pot after two inhalations depending on the User taste and preference for extraction of active ingredients during aromatherapy.

Starting at low power levels and going slow.

5 to 7 inhalations per Ceramic Oven Pot or until no fresh aromas are produced to taste at the set power level.

Begin at a low power level setting and gradually increase the temperature for subsequent inhalations or if more vapor is desired.

Stirring the granulated herb or flower within the Ceramic Oven Pot with the Stir Tool after every 3 inhalations depending on the physical properties, moisture content and humidity levels of the organic material. This is most important if the user delays complete extraction of active ingredients of the herbs or flowers. Once cooled, the organic material in the Ceramic Oven Pot may solidify and require a few stirs to loosen up the material for ideal airflow prior to restarting an aromatherapy session with half extracted material.

J. Locking and Power Off the Puck

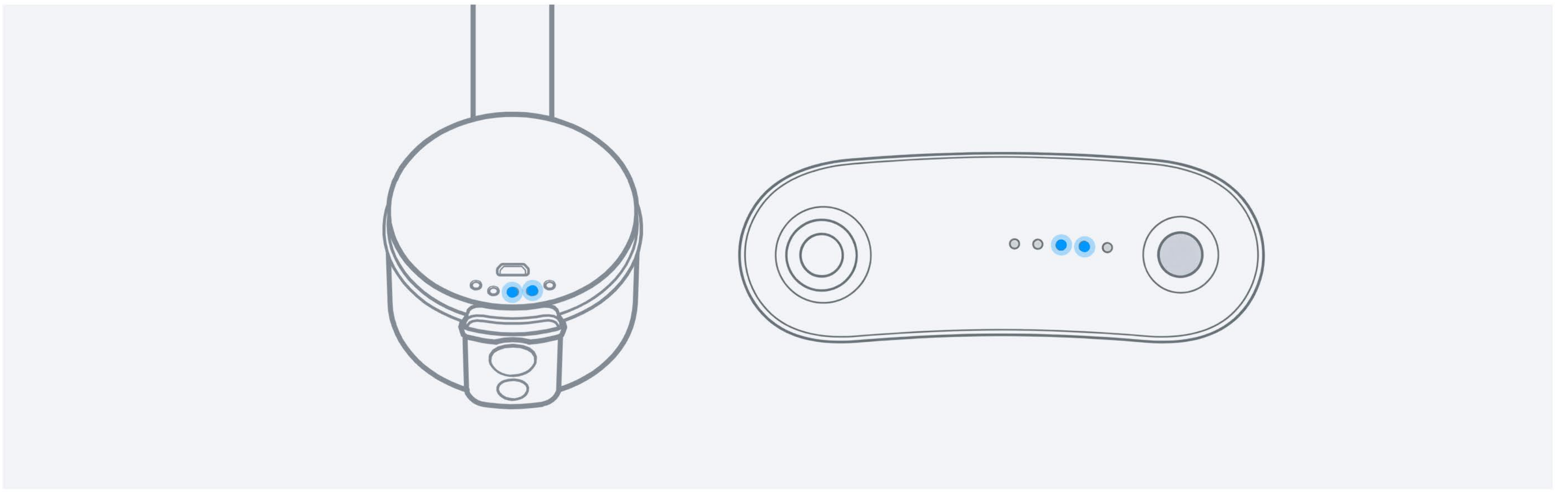

To shut down and lock the puck base unit. The User must click the Fire button 3 or more times with less than 0.3 second gap between clicks.

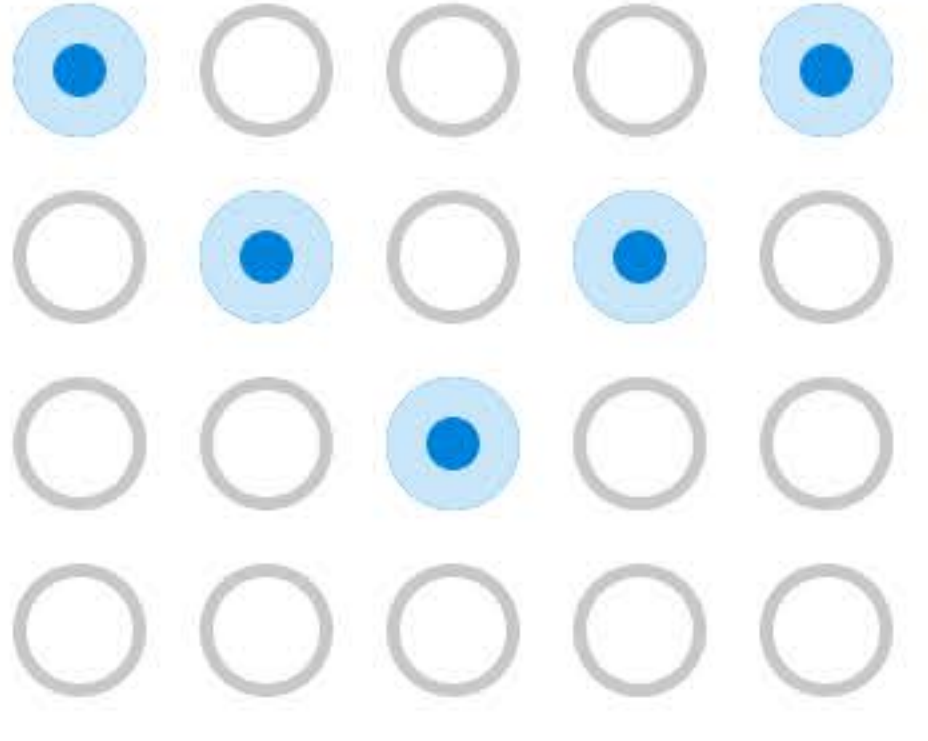

## 06: OPERATION OF POTTER HERB SHREDDER

Bowle features a purpose designed micro dose loading system called Potter™. Potter™, is the herb shredding system designed for performance and ease of use specifically to granulate organic herbs dispersed into Ceramic Oven Pots for use in Bowle.

### A. Recommendations

- Always wash your hands thoroughly before dispensing herbs for aromatherapy or touching the Ceramic Oven Pots.
- Always dispense the granulated herbs and flowers into the Ceramic Oven Pots using the Herb Shredder.
- Load as close to or exactly 0.40 grams of herb or flower material in Potter for shredding. Potter is designed to promote micro-dosing and disperses 0.10 grams of herb or flower into each Ceramic Oven Pot.
- Always endeavor to empty the extracted contents left over after each aromatherapy session is completed from the Ceramic Oven Pots. It helps to better maintain the performance of the Ceramic Oven Pots by preventing organic materials from clogging the stainless steel screen at the base of the Ceramic Oven Pots.
- Replace the Potter Herb Shredder Pot Tray with the supplied 'Funnel Cap' to shred herbs or flower into a single Ceramic Oven Pot. Revert to the Pots Tray to shred herbs into 4 Ceramic Oven Pots simultaneously.

### B. Assembling

#### Note:

Potter ships pre-assembled.



#### 1 of 6

- Begin by laying out the 3 pieces Herb Shredder and the 4 Ceramic Oven Pots.



#### 2 of 6

- Pick up the Oven Pot Tray (it is the portion of the Herb Shredder with slots to hold the Pots).



#### 3 of 6

- Place one Ceramic Oven Pot in each of the 4 available matching slots.



#### 4 of 6

- Ensure a Ceramic Oven Pot is placed in all slots of the Pot Tray.



#### 5 of 6

- Place the Mid Shredder on top of the Pot Trays with the Shredder Tooth on top.

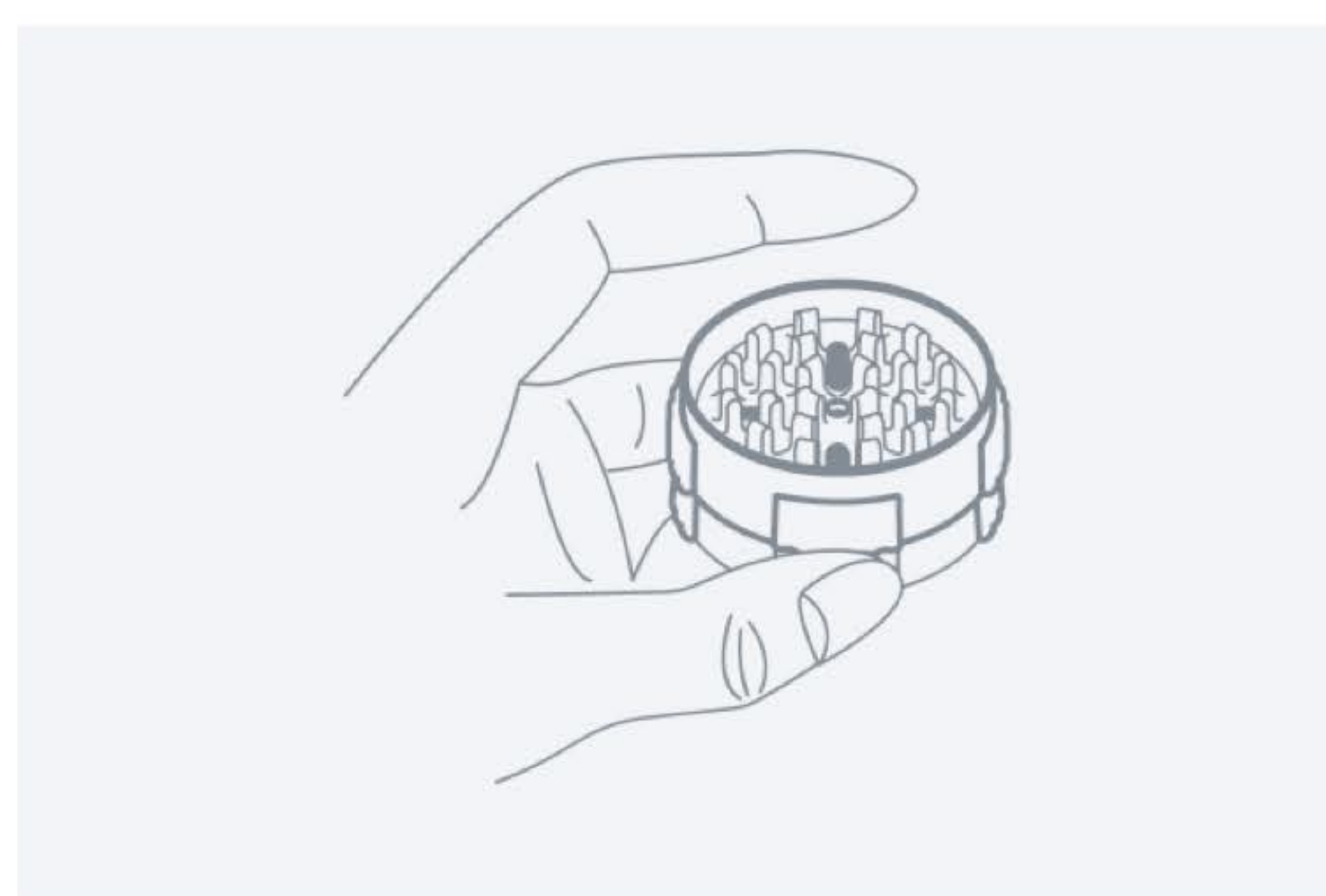

#### 6 of 6

- Correctly assembled, the Mid Shredder slits will be completely open and clear, with each slit right above an Oven Pot in the Pot Tray beneath.

### C. Loading Herb or Flower for Shredding

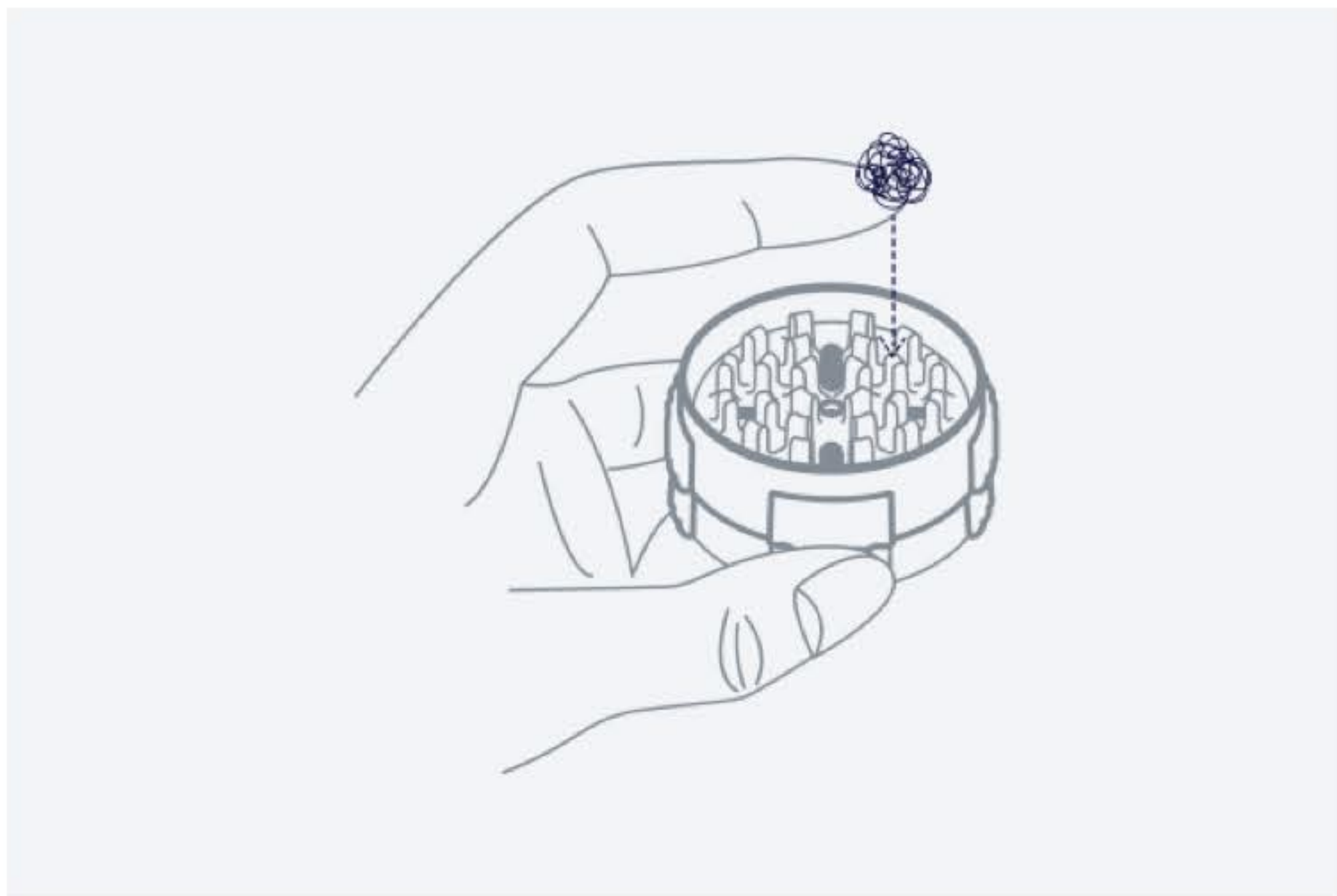

1 of 4

- Break off pinky-sized pieces of your herbs and place between the Shredder Tooth.



2 of 4

- Place an equal amount of the herb or flower across the available Shredder Tooth sections of the Mid Shredder.
- Take care to avoid the slits. Herbs placed above the slits may not be properly shredded and may clog the slits.
- **Note:** Only load about 0.40 gram of herbs or flower in total.

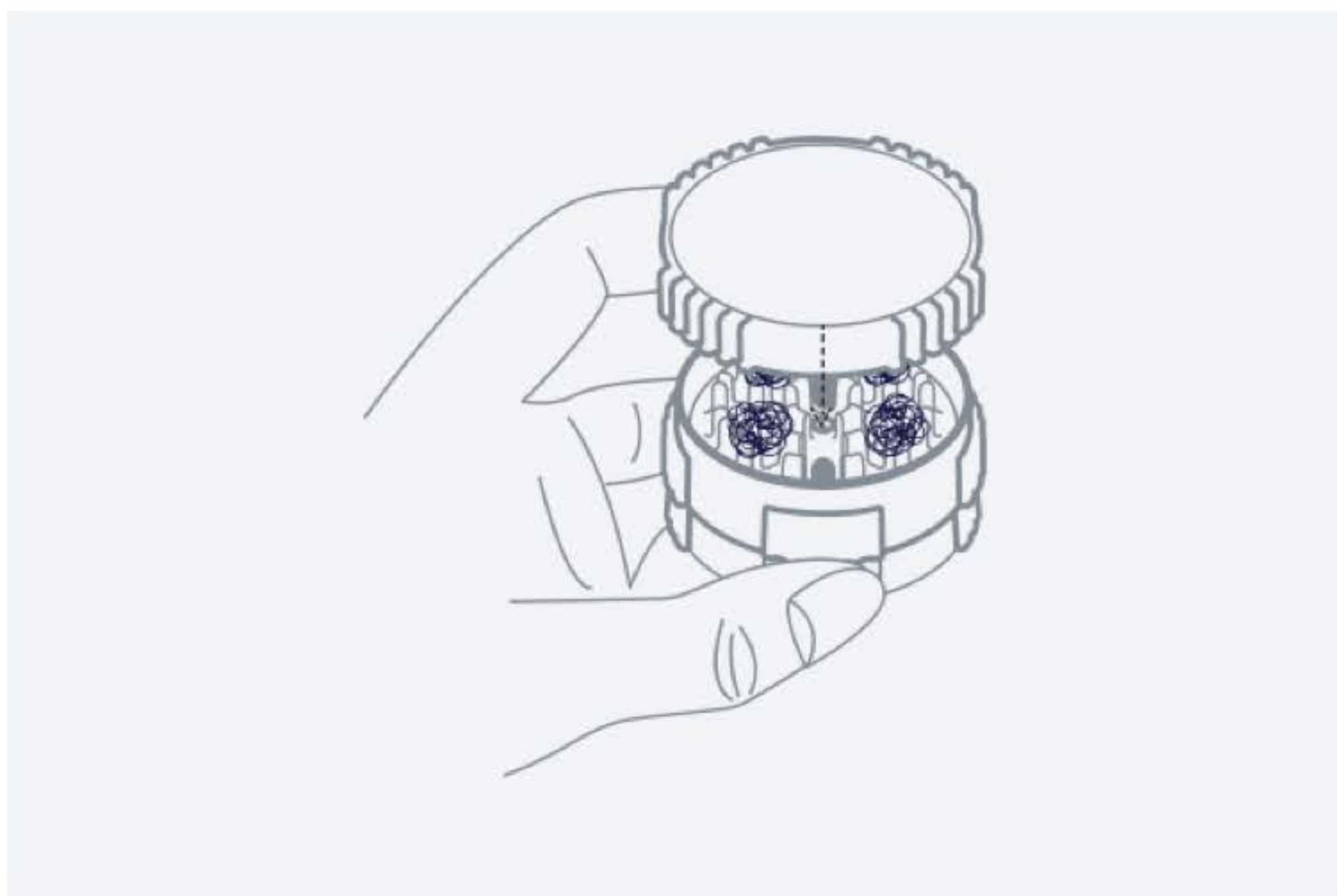

3 of 4

- Place the Top Shredder Dispenser on top of the Mid Shredder and the herbs between the Shredder Tooth sections. Press together firmly until it claps.

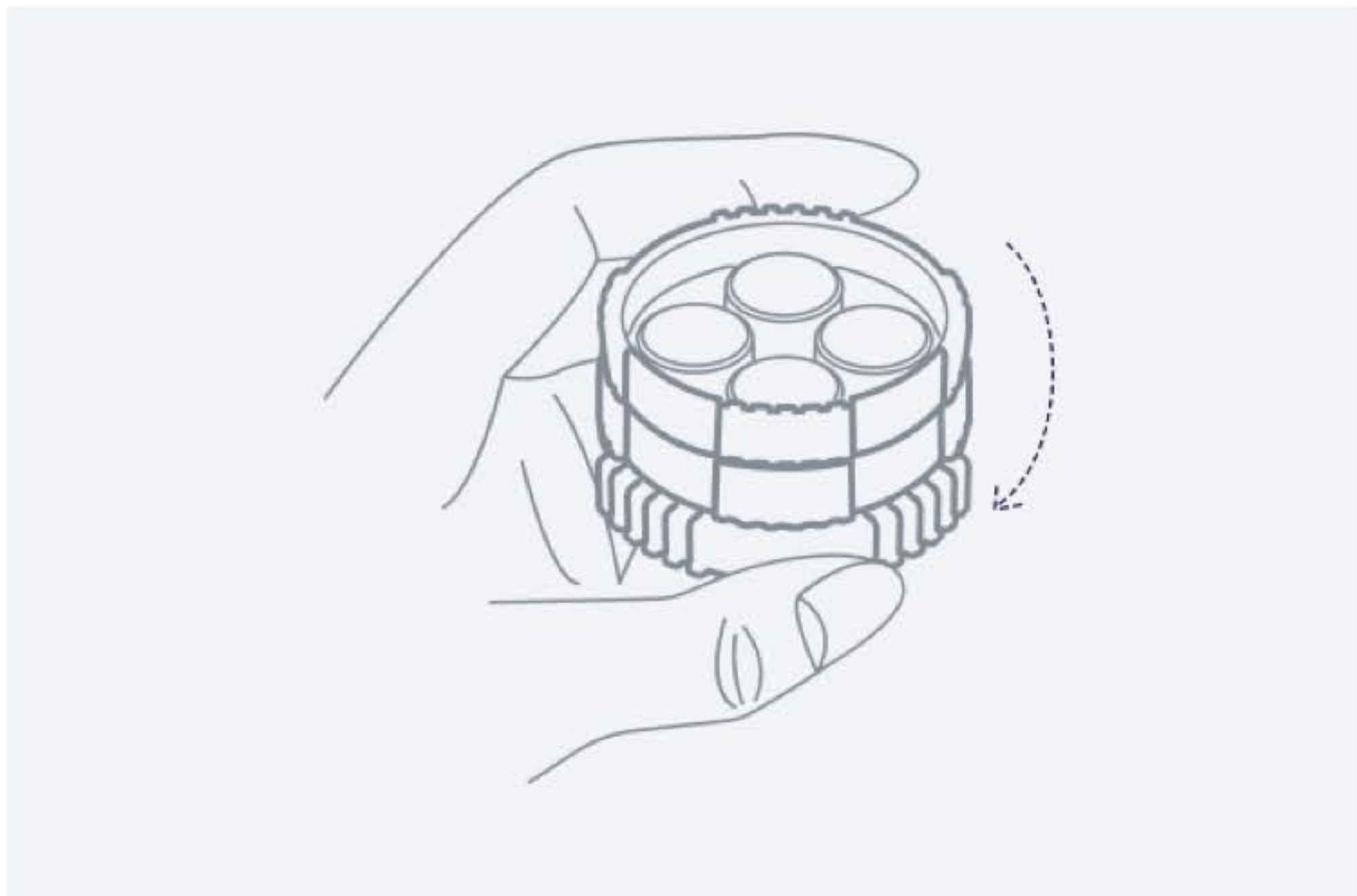

4 of 4

- With the Herb Shredder assembled, firmly press on the Top Shredder and turn the entire assembly upside down firmly clasped together.
- Twist both the Pot Tray and Mid Shredder Sections together to begin shredding.
- **Note:** Fine or coarse shreds of herbs are the best suited for the Bowle.

### D. Dispensing

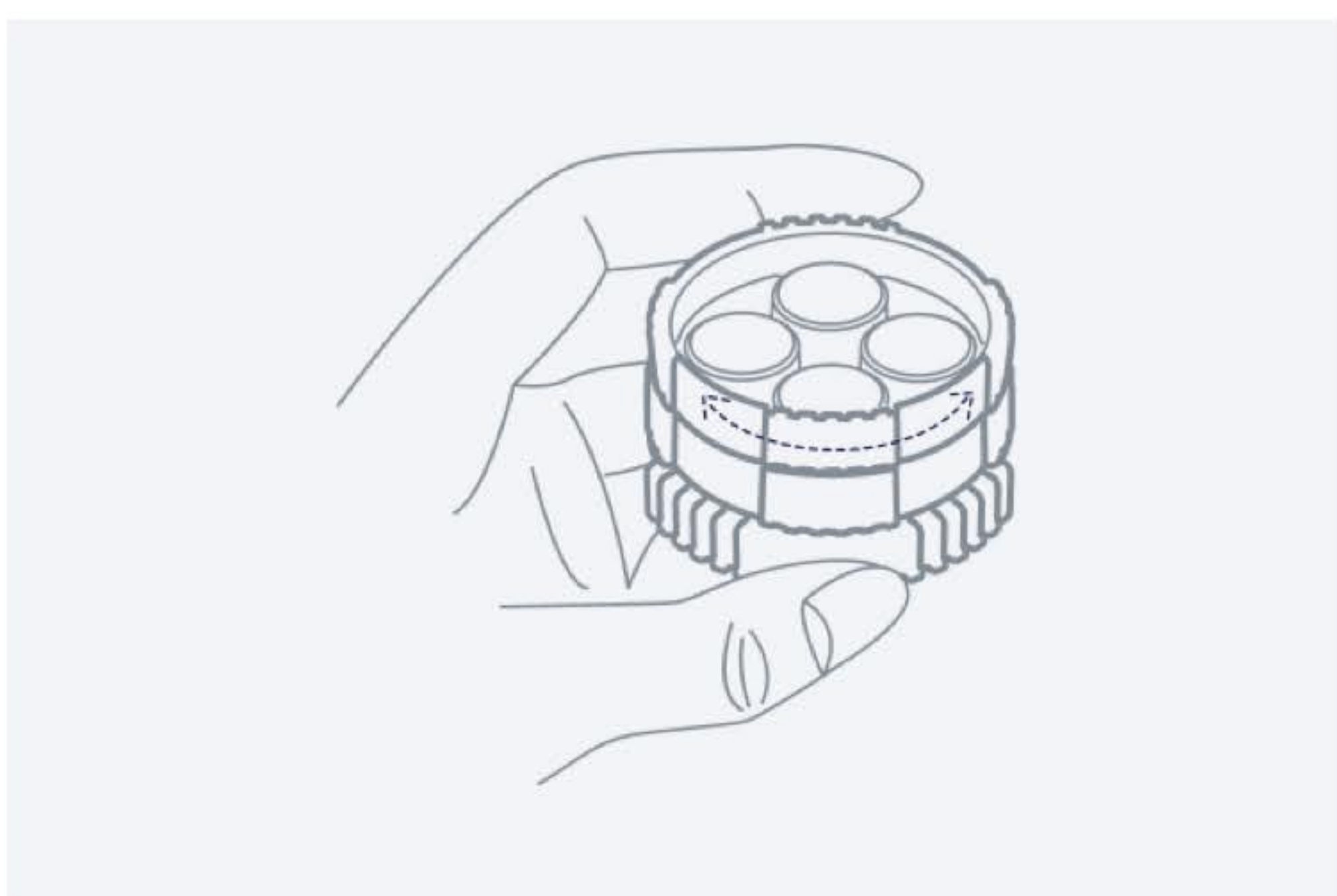

1 of 4

- Continue to shred the herbs for at least 6 clockwise or counterclockwise rotations.

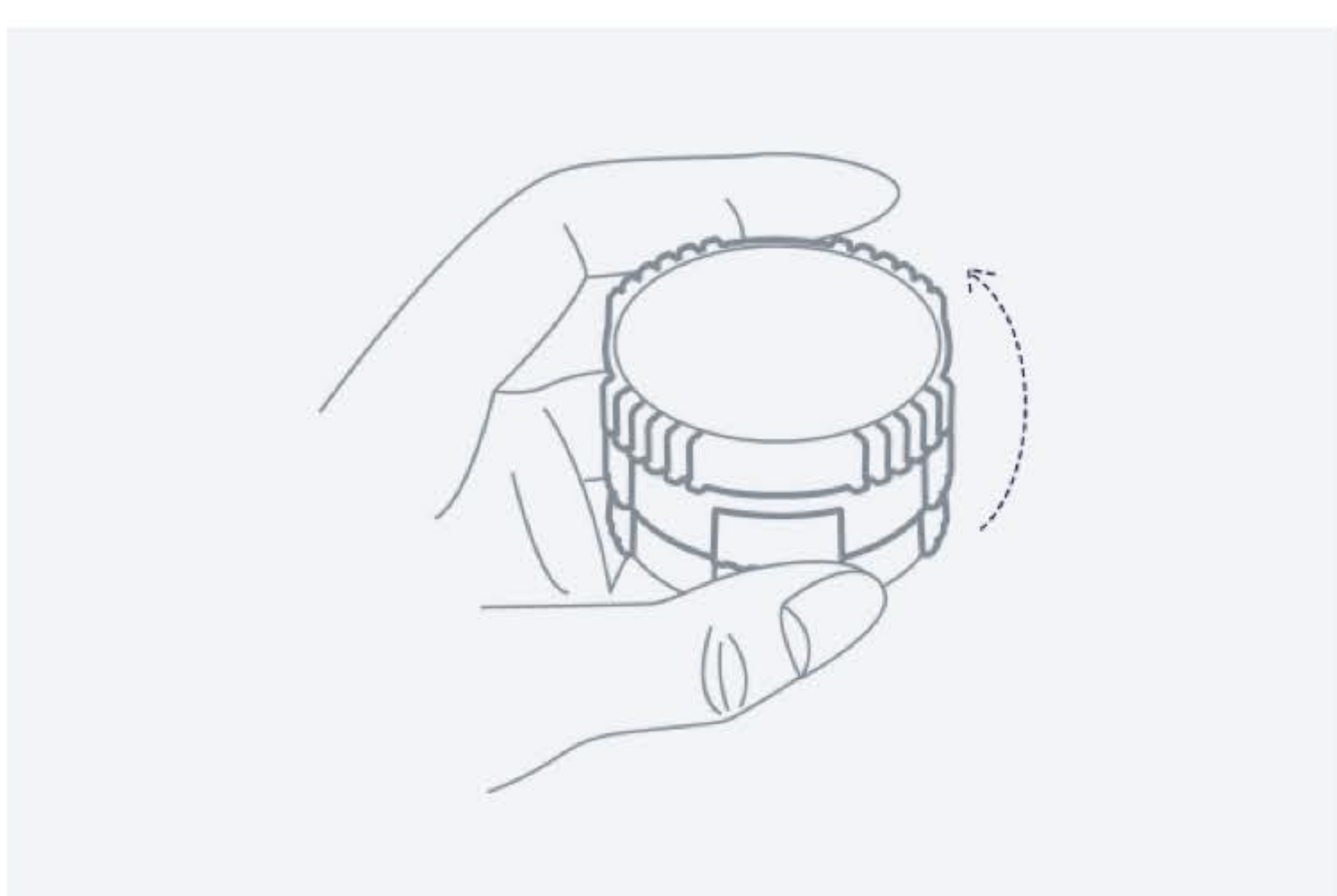

2 of 4

- Turn the Herb Shredder now right side up. Spin the Top Shredder Dispenser for at least 6 clockwise or counter clockwise rotations.
- Complete the dispensing of the shredded herbs by tapping the Herb Shredder on a firm flat surface.

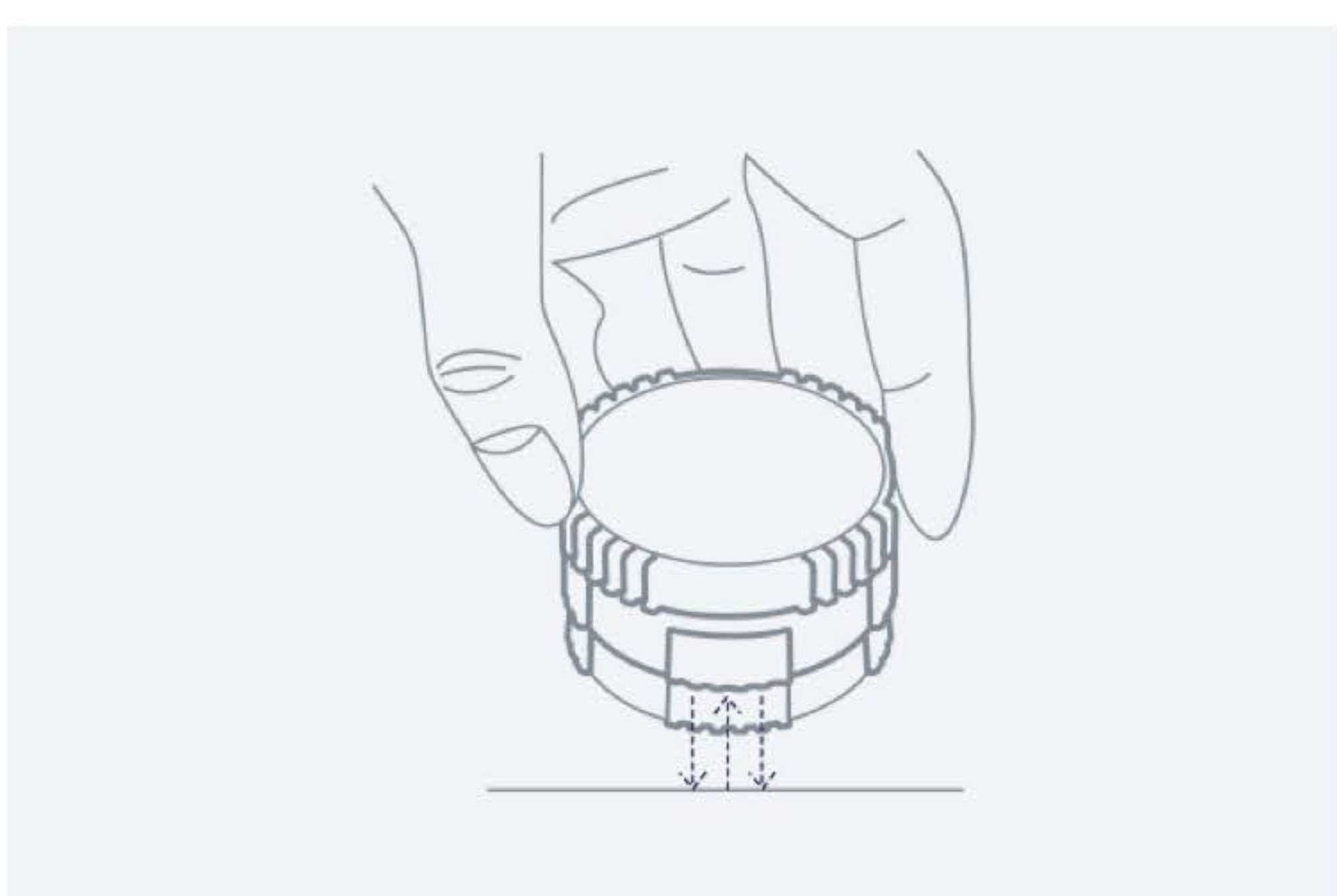

3 of 4

- Lift the Top Shredder Dispenser to confirm herbs have been dispersed into the Ceramic Oven Pots underneath the slits.
- Ensure no herbs remain in by repeating a few more rotations with the Top Shredder Dispenser.
- Remember to tap the Herb Shredder lightly twice on a flat surface to disperse whatever herbs that remain above the slits.



4 of 4

- Separate both the Mid Shredder with the Top Shredder Dispenser together to reveal the Ceramic Oven Pots holding the shredded herbs within the Pot Tray.

## 07: CARE AND MAINTENANCE

The device parts and accessories may require an external hygienic maintenance with extended use. Adhere to this cleaning guide to care and maintain your Bowle and accessories.

### A. Cleaning the Puck Base Unit

The Puck Base Unit is a low maintenance design. Only basic cleaning with a clean soft fiber cloth for maintenance is required, and this is based upon the frequency of use.

Before cleaning the Puck Base Unit, disconnect the charger from the socket. The Puck Base Unit and the charger should only be cleaned externally with a dry or very lightly damp cloth and must be wiped dry afterwards.

Never touch or interact with the oven screen or silicone ring inside/above the Puck Base Unit Stem Slot. Users are advised to not fill Pots to such level where material comes in contact with the Top of the Oven.

In the event particles of material settle or collect inside of the oven slot of the Puck Base Unit. Use the included soft bristle cleaning brush lightly and gently to clean away the particles.



#### Note:

**NEVER** interact with the oven bay screen in the stem slot of Bowle or Flaske. Doing so will damage your device. Damage to the screen is not covered under your warranty.

### B. Cleaning Stem, Mouthpieces, Ceramic Oven Pots, Drinkware, and Herb Shredder

The Stem, Mouthpieces and Ceramic Oven Pots, should be cleaned when:

- There are visible large collections of particles or residue inside.

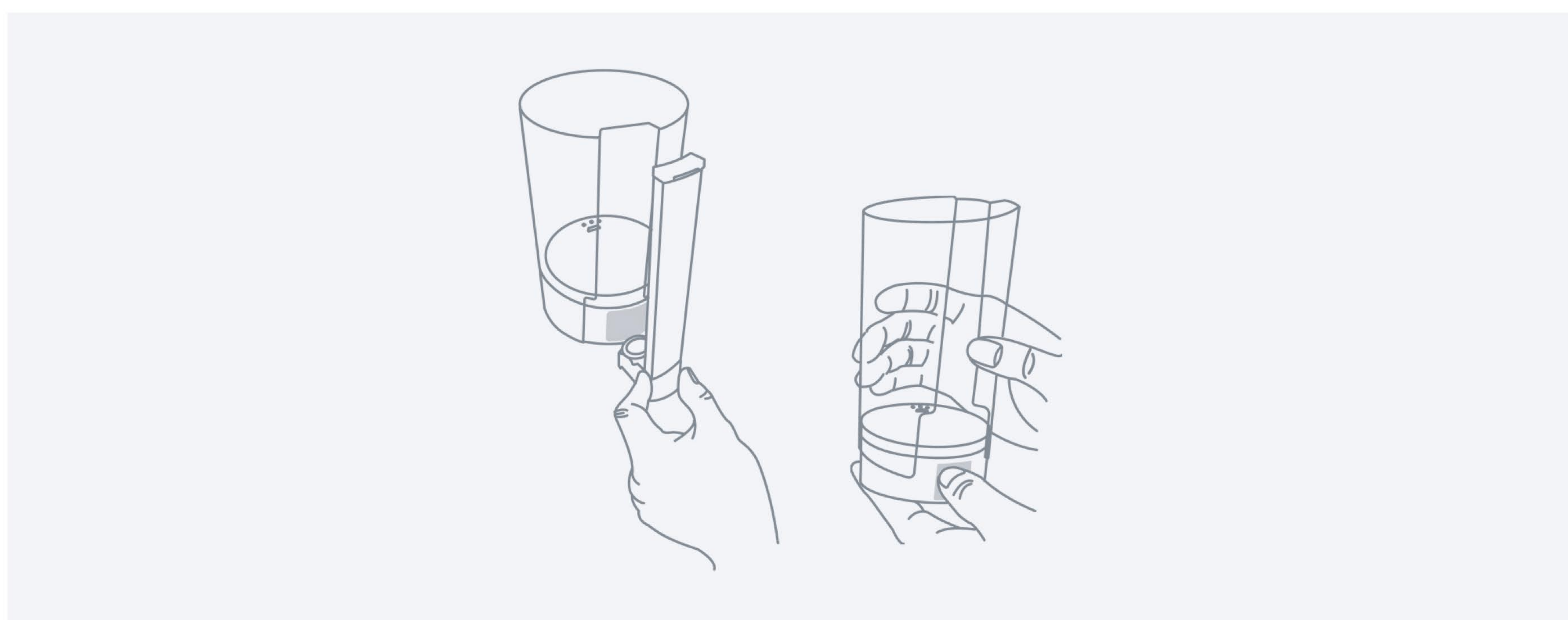

Before cleaning these accessories:

- Detach the Stem from the Puck Base Unit, also separate the Ceramic Oven Pot and Mouthpiece from the Stem.
- Do not separate the stainless steel screen from the ceramic pot when cleaning.
- Separate the sealing gasket surrounding the Ceramic Oven Pot. The stainless steel screen in the ceramic oven pots do not need to be separated for cleaning. The Puck Base Unit and Charger should NOT be near the cleaning area.

Use a soft tube brush, finger or cotton swabs to remove any internal residue.

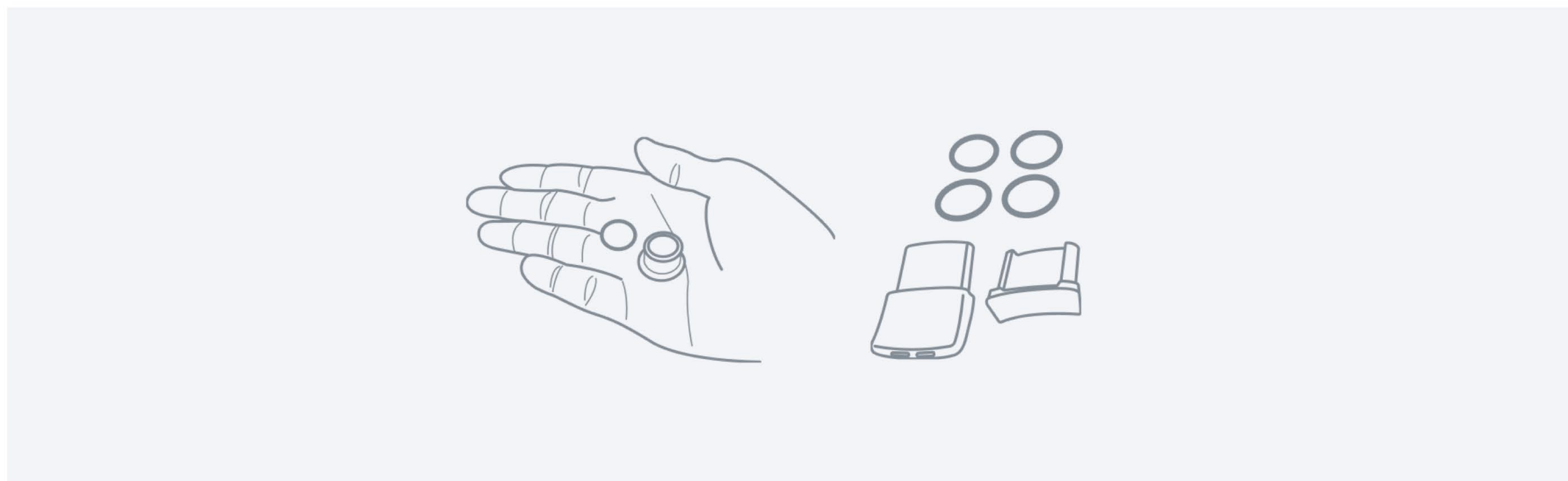

For deep cleaning, immerse ONLY the following parts completely in Ethanol or Isopropyl alcohol for cleaning (Ceramic Pots and Stem Only). Afterwards they should be thoroughly rinsed in warm water possibly after also using a non-toxic pH balanced dish cleaning detergent.

Both the Ceramic Oven Pot and the Stem must be completely dried with a soft absorbent cloth internally and externally. The Stem may need to be shaken and blown with air a few times to dislodge water residue left internally after cleaning.

Do not allow standing water to remain inside of the stem after cleaning.

### Ceramic Oven Pots

The Ceramic Oven Pots along with its stainless-steel screen bottom may be cleaned together. (Make sure to remove the gasket surrounding the Ceramic Oven Pot first. Also, make sure to remember to place this small gasket at a safe place remembering to place it back around the Ceramic Oven Pot for the Ceramic Oven Pot to be functional for use after cleaning in the Stem.

Failure to re-insert the silicone gasket around the ceramic pots after cleaning will result in no function from the Bowle.

### The Stem

Lay flat on its sides in a deep-dish Tupperware or, in a tumbler with the lower Ceramic Oven Pot housing of the Stem completely immersed inside the cleaning substance for up to 12 hours. Never unscrew or disassemble the base of the stem to clean.

### The Mouthpiece

The mouthpiece or silicone gaskets should not be placed in ISO. They can be soaked in warm water and washed with non-toxic dish cleaning detergent. It should be rinsed in warm water for at least 5 minutes to remove all traces of soap before drying for use.

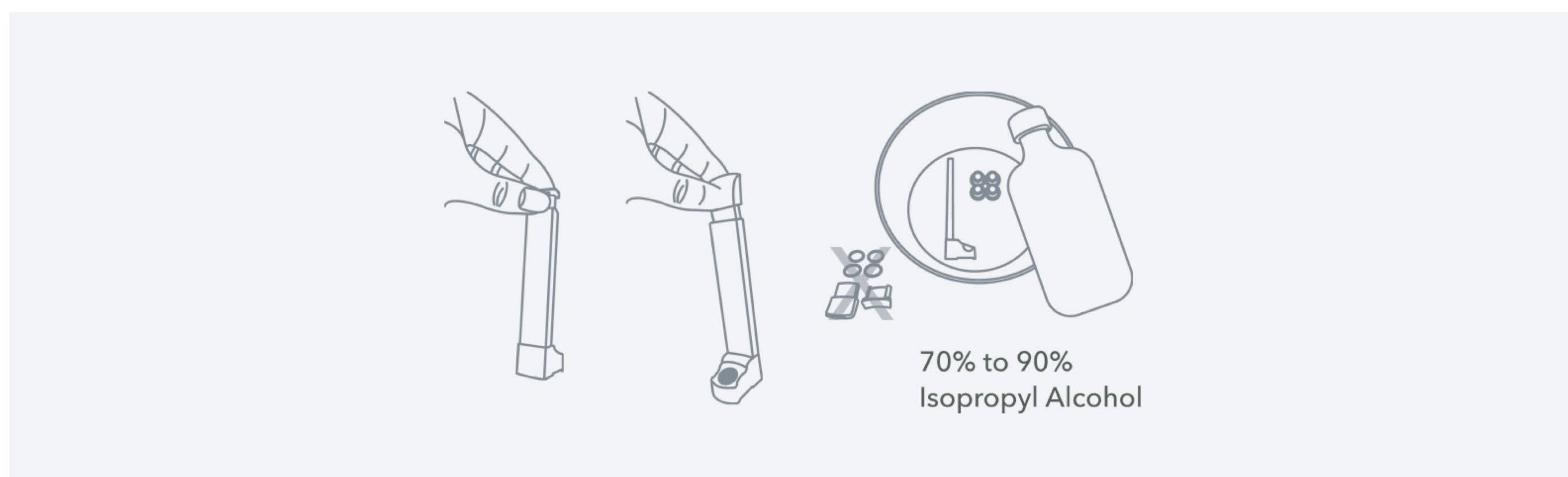

### The Drinkware

The Drinkware should be cleaned after each use. Tafée suggest rinsing in warm water and a soft cloth wash with a non-toxic dish washing detergent. After which the Drinkware should be cleaned dry with a clean microfiber cloth to prevent scratches and swirls. Alternatively, the Drinkware may be also cleaned in a Dishwasher (at the top section of your dishwasher). Tafée recommends hand wash. Never clean or soak Drinkware in isopropyl.

### Potter Herb Shredder

Potter Herb Shredder should be cleaned using the supplied maintenance kit when the corners of the shredder lodge particles that interfere with operation. The brush and the pick/stir tool may be used to dislodge accumulated particles over time and maintain the functionality of the shredder.

The cleaning time depends on the accumulated residue.

Never boil the accessories or immerse in hot water. High temperatures or lengthy exposure to cleaning agents may deform or discolor the accessories.

Never clean or soak Potter+ acrylic versions in isopropyl or ethanol.

## 08: SPARE PARTS AND ACCESSORIES

Part Name	Part Number
Puck Base Unit	VEE2020
Drinkware	10036
Stem	00007
Oven Pots (4)	10012
USB Charger	10288
USB Cord	10199
Mouthpiece — Flat	10025
Mouthpiece — Long	10005
Herb Shredder	10041
Cleaning and Maintenance Kit	10027















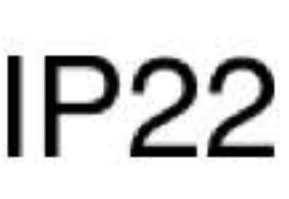









## 09: TROUBLESHOOTING

You can detect malfunctions that occur during daily operation yourself. The LED displays will help you to diagnose and correct the causes of malfunction.

Display	Possible Cause	Solution
The Puck Base Unit cannot be switched on.	The battery may be fully drained.	<ul style="list-style-type: none"> <li>Please ensure that the Puck Base Unit battery is charged or is connected via the power adapter to a functioning main socket.</li> <li>It may take up to 10 seconds for the Puck Base Unit to indicate the charging status via the LED's as the devices evaluate the cause at fault for the initial total discharge.</li> <li>If there isn't any indication of Power and at least multiple Power outlets have been tried by the User without success, then the device is faulty. In this case, disconnect from the mains without delay and get in touch immediately with our Service Center.</li> <li>It is likely that your device entered a safety lockout due to experiencing an electrical surge while connected to charge.</li> <li>We err on the side of extreme caution and would need to quickly inspect the device in such cases to ensure no components have been damaged before further use.</li> </ul>
A pink or white LED turns on sometimes on my device.	The behavior you are observing is a known, harmless event that can occasionally appear during the use of a Bowle device. This LED light activity is a firmware-driven visual indicator originally designed for testing feedback, triggered when the device enters standby shortly after activation. It reflects a periodic evaluation of the battery cells or their return to a stable state following a high-discharge session.	<ul style="list-style-type: none"> <li>Typically, this light event stops appearing after a few full charge cycles, as the firmware adapts to the battery's performance baseline. It has no impact on the Bowle's operation or safety. If needed, the light can be manually turned off by clicking the small power select button while the device is in standby. Please rest assured that this LED activity does not affect battery life.</li> <li>The battery is only actively depleted when the heater is engaged; the LEDs themselves draw negligible power. Your device is functioning perfectly normally, and this visual effect will diminish over the course of a few sessions.</li> </ul>
The Puck Base Unit cannot be switched on.	The battery may be exposed to extreme temperatures.	<ul style="list-style-type: none"> <li>Battery temperature is too high or low. Relocate the Puck Base Unit from the impacting temperature environment and allow the to cool down or warm up prior to attempting powering on.</li> </ul>
The Puck Base Unit does not indicate charging.	The battery may be fully charged.	<ul style="list-style-type: none"> <li>This can be confirmed if all the LED's flash Blue twice and go off after disconnecting and reconnecting the charging cable.</li> </ul>
The Puck Base Unit does not indicate charging.	The Puck Base Unit may not be charging the battery.	<ul style="list-style-type: none"> <li>The power adapter is not suitable. Please use an original Tafée power adapter.</li> </ul>
The Puck Base Unit does not indicate charging.	The Puck Base Unit may be faulty.	<ul style="list-style-type: none"> <li>In this case, disconnect from the mains without delay and get in touch immediately with our Service Center.</li> </ul>
The LED does not turn Solid Green after the Fire button is clicked to begin inhalation.	The battery level may be fully depleted.	<ul style="list-style-type: none"> <li>Please use an original Tafée power adapter to recharge the battery.</li> </ul>
The LED does not turn Solid Green after the Fire button is clicked to begin inhalation.	The Puck Base Unit may need to be reset.	<ul style="list-style-type: none"> <li>Disconnect it from the charger if it is connected.</li> <li>Click both the Fire and Power Level Select button together in rapid succession 5 times to hard reset the Puck Base Unit.</li> <li>Connect the plugged power adapter to the Puck Base Unit to reboot and wake up the Puck Base Unit.</li> <li>If the problem persists, disconnect the Puck Base Unit from the mains without delay and get in touch immediately with our Service Center.</li> </ul>
The User does not produce any vapor when user exhales through the Stem.	The User inhalation time is less than required.	<ul style="list-style-type: none"> <li>Make sure to inhale at a steady pace like consuming a thick beverage like a milkshake or smoothie through a straw for at least 8 seconds continuously.</li> </ul>
The User does not produce any vapor when user exhales through the Stem.	The Ceramic Oven Pot in the Stem may not be placed properly.	<ul style="list-style-type: none"> <li>Make sure the Ceramic Oven Pot has its 'O' ring silicone gasket placed beneath the rim of the Oven Pot. The Stem along with the Oven Pot placed in it must have a tight fit and seal when inserted into the Puck Base Units oven slot.</li> </ul>
The User does not produce any vapor when user exhales through the Stem.	The Herbs may not be granulated to an ideal consistency.	<ul style="list-style-type: none"> <li>Granulate the herbs to a semi-fine grind and pack the Ceramic Oven Pot loosely to a maximum of 75% volume capacity.</li> <li>The Potter shredder should be used to granulate and fill the Ceramic Oven Pots to be placed in the Stem for inhalation.</li> </ul>
The User does not produce any vapor when user exhales through the Stem.	The Organic Compounds contained within the Herbs and Flowers in the Ceramic Oven Pot are "spent" and completely evaporated at the power level selected.	<ul style="list-style-type: none"> <li>Click the power level select button to increase to a higher temperature. If no vapor is produced at the highest temperature, then the herbs or organic compounds have been completely evaporated and must be discarded and replaced with a fresh batch.</li> </ul>
The User does not produce any vapor when user exhales through the Stem.	Malfunctioning button control.	<ul style="list-style-type: none"> <li>Try clicking and holding on to the Fire button throughout the inhalation. If the LED's remain green during steady inhalation doing this method, it confirms a malfunctioning button. Please contact the service center for help.</li> </ul>

Display	Possible Cause	Solution
The Herbs or organic compounds in the Ceramic Oven Pot are charred or burned.	The Ceramic Oven Pot is packed too tightly.	<ul style="list-style-type: none"> <li>Reduce the volume of herbs in the Ceramic Oven Pot. The oven Pot should never be packed to more than 75% volume capacity or packed in a tightly compressed manner. Each Ceramic Oven Pot is designed to micro dose 0.10grams of granulated herb only.</li> </ul>
The Herbs or organic compounds in the Ceramic Oven Pot are charred or burned.	The starting temperature is too high.	<ul style="list-style-type: none"> <li>Reduce the operating power level with the power level select button to begin at a lower temperature setting.</li> <li>Alternatively, stir the contents of the Ceramic Oven Pot after every inhalation with the stir tool.</li> </ul>
The Herbs or organic compounds in the Ceramic Oven Pot are charred or burned.	The herbs are not granulated to required consistency.	<ul style="list-style-type: none"> <li>Granulate the herbs to a semi-fine grind and pack the Ceramic Oven Pot loosely to a maximum of 75% volume capacity.</li> <li>The Potter shredder should be used to granulate and fill the Ceramic Oven Pots to be placed in the Stem for inhalation.</li> </ul>
The Herbs or organic compounds in the Ceramic Oven Pot are charred or burned.	User is inhaling incorrectly.	<ul style="list-style-type: none"> <li>Experiment with various inhalation techniques to arrive at a desired inhalation method.</li> <li>Try at least 6 seconds of continuous steady inhalation from the mouthpiece, at a similar pace or intensity to inhaling air orally from a large drinking straw to begin.</li> <li>Alternatively try to inhale at a steady pace like consuming a thick beverage like a milkshake or smoothie through a straw for at least 8 seconds continuously.</li> </ul>
The Oven does not shut down after inhalation.	Electrical malfunction.	<ul style="list-style-type: none"> <li>Immediately stop using the device and immediately contact the customer service center for servicing.</li> <li>Do not connect the Puck Base Unit to the charger or any power port. Click on both the Fire and Power Level Select Button 5 times in very rapid succession to shut down the unit and place it in complete lockout.</li> </ul>
The Puck Base Unit is too hot.	Too much continued use.	<ul style="list-style-type: none"> <li>Bowle is designed for one user at a measured pace of demand. As an on-demand device in a compact enclosure, it is inevitable to achieve higher than preferred temperatures if the device is used without pause in-between sessions.</li> </ul>
The Puck Base Unit is too hot.	Exposure to direct sunlight.	<ul style="list-style-type: none"> <li>Please relocate the Device from any areas with direct exposure to sunlight which may cause overheating of the device. In the event the device overheats do not attempt to use it until it has been relocated a room temperature environment and has cooled down adequately to normal operating ranges.</li> </ul>

## 10: LIST OF SYMBOLS

	Serial number of the Bowle		CE marking product in compliance to the directives 93/42/EEC		Manufacturer name and address
	Box and packaging can be recycled		Device is protected against moisture and water spray		Applicable part BF
	Equipment must only be used indoors		Warning. Read carefully.		Read the Instructions Manual
	ETL conformity symbol; Product in compliance to North American safety standards		Safety category II device		Do not dispose of this product in normal household waste
	CSA conformity symbol CAN/CSA-C22.2 No. 64		Hot surface		Dispose in the most appropriate manner
	The product is not sterile		Air pressure limits		Restriction on the use of hazardous substances in compliance to 2011/65/EU
	USB connector		Operating and storing temperature limits		Protect against rain or humidity.
	Humidity limits		AC: alternating current		DC: direct current

## 11: WARRANTY AND CUSTOMER SERVICE

Tafée™ guarantees to you that if used for its intended purpose the Bowle® will be free from defects in material or workmanship caused by the manufacturing process for the warranty period of two years.

This warranty does not cover accessories or device parts exposed to normal use, such as the Mouthpiece, Drinkware, Stem, Ceramic Oven Pots and Herb Shredder.

The warranty shall no longer be valid if:

- The device has been operated or used in a manner inconsistent with the guidelines in the instructions for use.
- Damage is evident that is attributable to external factors such as water, fire, lightning strike, microwaves or similar.
- The damage has been caused by transporting the device incorrectly, or resulted from a fall.
- The device has been handled or serviced incorrectly.
- The serial number on the device has been changed, removed or rendered illegible.
- Repairs, adaptations or modifications have been made to the device by persons not authorized by Tafée.

If a defect does occur, Tafée™ will replace the device. The device may be replaced with an identically or at least comparably equipped model. Replacement of the device shall not serve as grounds for new claims under the warranty. All exchanged used devices or parts will become the property of Tafée™. All other claims under the warranty are excluded to the extent permitted by law. In the event of a claim under the warranty, please contact your local service partner. The original purchase receipt from the dealer must be presented as proof of warranty and ownership. This warranty applies solely for the initial purchaser of the device.

### Customer Service

For further information or assistance with your Bowle®, warranty claims, consumer feedback, and to report technical problems, please contact Tafée's customer service:

Tafée Technologies Corporation  
4104 Fairview St #5  
Burlington, ON  
L7L 4Y8  
Canada

Email: [support@tafee.com](mailto:support@tafee.com)

For Bowle repair, please contact the Tafée's customer service before shipping. The serial number and your full contact details are required so that Tafée can issue a 'service reference number'.

Please note that the serial number SN is printed on the bottom of the Bowle.

